

FOR USA

These are general Important Safety Instructions and certain items may not apply to all appliances.

Important Safety Instructions

1. Read these instructions.
2. Keep these instructions.
3. Heed all warnings.
4. Follow all instructions.
5. Do not use this apparatus near water.
6. Clean only with dry cloth.
7. Do not block any ventilation openings. Install in accordance with the manufacturer's instructions.
8. Do not install near any heat sources such as radiators, heat registers, stoves, or other apparatus (including amplifiers) that produce heat.
9. Protect the power cord from being walked on or pinched particularly at plugs, convenience receptacles, and the point where they exit from the apparatus.
10. Only use attachments/accessories specified by the manufacturer.
11. Use only with the cart, stand, tripod, bracket, or table specified by the manufacturer, or sold with the apparatus.
When a cart is used, use caution when moving the cart/apparatus combination to avoid injury from tip-over.
12. Unplug this apparatus during lightning storms or when unused for long periods of time.
13. Refer all servicing to qualified service personnel.
Servicing is required when the apparatus has been damaged in any way, such as power-supply cord or plug is damaged, liquid has been spilled or objects have fallen into the apparatus, the apparatus has been exposed to rain or moisture, does not operate normally, or has been dropped.



POUR LES ÉTATS-UNIS

Ces informations sont des **CONSIGNES DE SÉCURITÉ IMPORTANTES** et certains points peuvent ne pas s'appliquer à tous les appareils.

CONSIGNES DE SÉCURITÉ IMPORTANTES

1. Lire ces instructions.
2. Conserver ces instructions.
3. Tenir compte de tous les avertissements.
4. Respecter toutes les instructions.
5. Ne pas utiliser cet appareil à proximité de l'eau.
6. Ne nettoyer qu'avec un chiffon sec.
7. Ne pas boucher les ouvertures de ventilation.
Installer selon les instructions du fabricant.
8. Ne pas installer à proximité de sources de chaleur telles que des radiateurs, des accumulateurs de chaleur, des poêles, ou d'autres appareils (comprenant les amplificateurs) qui produisent de la chaleur.
9. Protéger le cordon d'alimentation pour éviter qu'il ne soit piétiné ou ne se coince, tout particulièrement au niveau de la fiche, de la prise de courant et du point où il sort de l'appareil.
10. Utiliser uniquement des équipements/accessoires spécifiés par le fabricant.
11. N'utiliser qu'avec le chariot, le stand, le trépied, le support ou la table spécifié par le fabricant, ou vendu avec l'appareil.
Lorsqu'un chariot est utilisé, faire attention pour déplacer la combinaison chariot/appareil pour éviter des blessures causées par un basculement.
12. Débrancher cet appareil pendant un orage ou quand il n'est pas utilisé pendant une longue durée.
13. L'entretien ou la réparation de l'appareil doit être effectué par du personnel qualifié uniquement. Un dépannage est nécessaire lorsque l'appareil a été endommagé d'une façon ou d'une autre, telle que lorsque le cordon d'alimentation ou la fiche est endommagé, si du liquide a été renversé ou si des objets sont tombés à l'intérieur de l'appareil, si l'appareil a été exposé à la pluie ou à l'humidité, ne fonctionne pas normalement ou a fait une chute.



Safety Precautions

FOR USA AND CANADA



CAUTION

RISK OF ELECTRIC SHOCK
DO NOT OPEN



CAUTION:

TO REDUCE THE RISK OF ELECTRIC SHOCK. DO NOT REMOVE COVER (OR BACK). NO USER-SERVICEABLE PARTS INSIDE. REFER SERVICING TO QUALIFIED SERVICE PERSONNEL.



The lightning flash with arrowhead symbol, within an equilateral triangle is intended to alert the user to the presence of uninsulated “dangerous voltage” within the product’s enclosure that may be of sufficient magnitude to constitute a risk of electric shock to persons.



The exclamation point within an equilateral triangle is intended to alert the user to the presence of important operating and maintenance (servicing) instructions in the literature accompanying the appliance.

POUR CANADA



ATTENTION

RISQUE D'ELECTROCUTION
NE PAS OUVRIR



ATTENTION:
POUR EVITER TOUT RISQUE D'ELECTROCUTION NE PAS OUVRIR LE BOITIER. AUCUNE PIECE INTERIEURE N'EST A REGLER PAR L'UTILISATEUR. SE REFERER A UN AGENT QUALIFIE EN CAS DE PROBLEME.



Le symbole de l'éclair à l'intérieur d'un triangle équilatéral est destiné à alerter l'utilisateur sur la présence d'une “tension dangereuse” non isolée dans le boîtier du produit. Cette tension est suffisante pour provoquer l'électrocution de personnes.



Le point d'exclamation à l'intérieur d'un triangle équilatéral est destiné à alerter l'utilisateur sur la présence d'opérations d'entretien importantes au sujet desquelles des renseignements se trouvent dans le manuel d'instructions.

Ces symboles ne sont utilisés qu'aux Etats-Unis.

Supplier's Declaration of Conformity

Model Number: KY-PZ510NWU/KY-PZ510NBU
KY-PZ510WU/KY-PZ510BU

Trade Name: JVC
Responsible party: JVCENWOOD USA Corporation
Address: 1440 Corporate Drive, Irving, TX 75038

Telephone Number: 678-449-8879

This device complies with Part 15 of the FCC Rules. Operation is subject to the following two conditions: (1) This device may not cause harmful interference, and (2) this device must accept any interference received, including interference that may cause undesired operation.

Changes or modifications not approved by JVC could void the user's authority to operate the equipment. This equipment has been tested and found to comply with the limits for a Class A digital device, pursuant to Part 15 of the FCC Rules. These limits are designed to provide reasonable protection against harmful interference when the equipment is operated in a commercial environment.

This equipment generates, uses, and can radiate radio frequency energy and, if not installed and used in accordance with the instructions, may cause harmful interference to radio communications. Operation of this equipment in a residential area is likely to cause harmful interference in which case the user will be required to correct the interference at his own expense.

Déclaration de conformité du fournisseur
Numéro de modèle : KY-PZ510NWU/KY-PZ510NBU/
KY-PZ510WU/KY-PZ510BU

Nom de marque : JVC
Personne responsable : JVCENWOOD USA Corporation
Adresse : 1440 Corporate Drive, Irving, TX 75038

Numéro de téléphone : 678-449-8879

Cet ensemble se conforme à la partie 15 des règles de la FCC (Federal Communications Commission). Le fonctionnement est sujet aux deux conditions suivantes : (1) Cet appareil ne peut pas causer d'interférences nuisibles, et (2) cet appareil doit accepter toute interférence reçue, comprenant des interférences qui peuvent causer un mauvais fonctionnement.

Des changements ou modifications non approuvés par JVC peuvent annuler le droit de l'utilisateur de faire fonctionner l'appareil. Cet appareil a été testé et il a été reconnu qu'il se conforme aux limites concernant l'appareillage informatique de classe A correspondant à la partie 15 des règles de la FCC. Ces limites sont conçues pour fournir une protection raisonnable contre les interférences dangereuses lorsque l'équipement est utilisé dans un environnement commercial.

Cet appareil génère, utilise et peut émettre de l'énergie des fréquences radio et, s'il n'est pas installé et utilisé selon les instructions du fabricant, peut causer des interférences nuisibles en communications radio. L'utilisation de cet équipement dans une zone résidentielle est susceptible de causer des interférences néfastes, auquel cas l'utilisateur devra prendre des mesures à ses propres frais.

CAUTION:

The mains plug shall remain readily operable.

- Remove the mains plug immediately if the camera functions abnormally.

WARNING:

The battery pack, the camera with battery installed, and the remote control with battery installed should not be exposed to excessive heat such as direct sunlight, fire or the like.

WARNING: TO PREVENT FIRE OR SHOCK HAZARD, DO NOT EXPOSE THIS UNIT TO RAIN OR MOISTURE.

NOTES:

- The rating plate and safety caution are on the bottom and/or the back of the main unit.
- The serial number plate is on the bottom of the unit.
- The rating information and safety caution of the AC adapter are on its upper and lower sides.

CAUTION:

Risk of Explosion if Battery is replaced by an Incorrect Type. Dispose of Used Batteries According to the Instructions.

Attention:

La prise secteur doit être opérationnelle.

- Débranchez immédiatement la fiche secteur si le caméscope ne fonctionne pas normalement.

Avertissement:

Évitez d'exposer la batterie, le caméscope avec la batterie insérée ou la télécommande avec la batterie insérée à une chaleur excessive, telle que celle des rayons directs du soleil, d'un feu ou de tout autre source de chaleur.

AVERTISSEMENT : POUR EVITER LES RISQUES D'INCENDIE OU D'ELECTROCUTION, NE PAS EXPOSER L'APPAREIL A LA PLUIE NI A L'HUMIDITE.

REMARQUES :

- La plaque d'identification et l'avertissement de sécurité se trouvent sous l'appareil et/ou au dos.
- La plaque du numéro de série est située sur la partie inférieure de l'appareil.
- Les informations d'identification et l'avertissement de sécurité de l'adaptateur secteur sont situés sur ses côtés supérieur et inférieur.

ATTENTION:

Risque d'explosion si la batterie est remplacée par un type incorrect. Mettre au rebut les batteries usagées selon les instructions.

When the equipment is installed in a cabinet or on a shelf, make sure that it has sufficient space on all sides to allow for ventilation (10 cm (3-15/16") or more on both sides, on top and at the rear). Do not block the ventilation holes. (If the ventilation holes are blocked by a newspaper, or cloth etc. the heat may not be able to get out.) No naked flame sources, such as lighted candles, should be placed on the apparatus. When discarding batteries, environmental problems must be considered and the local rules or laws governing the disposal of these batteries must be followed strictly.

The apparatus shall not be exposed to dripping or splashing and that no objects filled with liquids, such as vases, shall be placed on the apparatus.

Do not point the lens directly into the sun. This can cause eye injuries, as well as lead to the malfunctioning of internal circuitry. There is also a risk of fire or electric shock.

CAUTION!

Connecting cables (Audio/Video, etc.) to this unit and leaving it on top of the TV is not recommended, as tripping on the cables will cause the unit to fall, resulting in damage.

Si le matériel est installé dans un coffret ou sur une étagère, s'assurer qu'il y a un espace suffisant sur tous les côtés pour permettre la ventilation (10 cm (3-15/16") ou plus sur les deux côtés, au dessus et à l'arrière).

Ne pas boucher les orifices de ventilation.

(Si les orifices de ventilation sont bouchés par un journal, un tissu, etc., la chaleur peut ne pas s'éliminer.)

Aucune source à flamme nue, telle que des bougies allumées, ne doit être placée sur l'appareil.

En jetant des batteries aux ordures, les problèmes d'environnement doivent être pris en considération et les réglementations locales ou la législation concernant le rebut de ces batteries doivent être strictement respectées.

L'appareil ne doit pas être exposé à de l'eau ou à des éclaboussures et les objets remplis de liquide, tels que des vases, ne doivent pas être placés sur l'appareil.

Ne dirigez pas l'objectif directement vers le soleil. Vous pourriez vous abîmer la vue et l'appareil pourrait être endommagé. Il y a aussi risque d'incendie ou d'électrocution.

Attention!

Avec des câbles (Audio/Vidéo, etc.) raccordés, il est recommandé de ne pas laisser le caméscope sur le dessus du téléviseur, car tirer sur les câbles pourrait faire tomber le caméscope, causant des dommages.

When using the AC adapter in areas other than the USA

The provided AC adapter features automatic voltage selection in the AC range from 110 V to 240 V.

USING HOUSEHOLD AC PLUG ADAPTER

In case of connecting the unit's power cord to an AC wall outlet other than American National Standard C73 series type, use an AC plug adapter called a "Siemens Plug" as shown.

For this AC plug adapter, please contact the local dealers in your area.

Plug Adapter

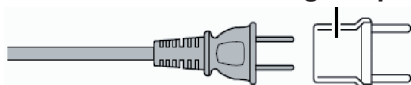

- Remove the AC adapter from the AC wall outlet when not in use.
- Do not leave dust or metal objects adhered to the AC wall outlet or AC adapter (power/DC plug).

Lorsque vous utilisez l'adaptateur secteur ailleurs qu'aux États-Unis

L'adaptateur secteur fourni dispose d'une sélection de tension automatique dans la plage CA de 110 V à 240 V.

UTILISATION D'UN ADAPTATEUR SECTEUR DE PRISE DOMESTIQUE

Si vous raccordez le cordon d'alimentation de l'appareil à une prise secteur autre que le modèle standard américain de série C73, utilisez un adaptateur de prise secteur appelé "Prise Siemens" comme indiqué.

Pour cet adaptateur secteur, veuillez contacter les distributeurs de votre région.

Adaptateur de prise

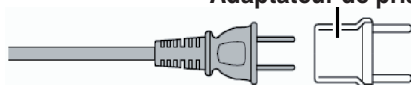

- Retirez l'adaptateur secteur de la prise murale lorsque vous ne l'utilisez pas.
- Veillez à ce que de la poussière ou des objets métalliques n'adhèrent sur la prise murale ou l'adaptateur secteur (prise d'alimentation/CC).

**IMPORTANT (for owners in the U.K.)
Connection to the mains supply in
the United Kingdom.
DO NOT cut off the mains plug from
this equipment.**

If the plug fitted is not suitable for the power points in your home or the cable is too short to reach a power point, then obtain an appropriate safety approved extension lead or contact the local dealers in your area.

BE SURE to replace the fuse only with an identical approved type, as originally fitted, and to replace the fuse cover.

If nonetheless the mains plug is cut off be sure to remove the fuse and dispose of the plug immediately, to avoid possible shock hazard by inadvertent connection to the mains supply.

If this product is not supplied fitted with a mains plug then follow the instructions given below:

DO NOT make any connection to the Larger Terminal coded E or Green. The wires in the mains lead are coloured in accordance with the following code:

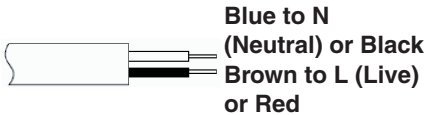

If these colours do not correspond with the terminal identifications of your plug, connect as follows:

Blue wire to terminal coded N (Neutral) or coloured black.

Brown wire to terminal coded L (Live) or coloured Red.

If in doubt — consult a competent electrician.

CAUTIONS:

- To prevent shock, do not open the cabinet. No user serviceable parts inside.
Refer servicing to qualified personnel.
- When you are not using the AC adapter for a long period of time, it is recommended that you disconnect the power cord from AC outlet.

CAUTION:

Where there are strong electromagnetic waves or magnetism, for example near a radio or TV transmitter, transformer, motor, etc., the picture and the sound may be disturbed. In such case, please keep the apparatus away from the sources of the disturbance.

CAUTION:

To avoid electric shock or damage to the unit, first firmly insert the small end of the power cord into the AC Adapter until it is no longer wobbly, and then plug the larger end of the power cord in to an AC outlet.

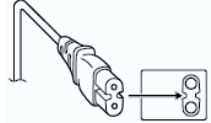

Dear Customer

This apparatus is in conformance with the valid European directives and standards regarding electromagnetic compatibility and electrical safety.

European representative of
JVCKENWOOD Corporation is:
JVCKENWOOD Deutschland GmbH
Konrad-Adenauer-Allee 1-11
61118 Bad Vilbel
GERMANY

Sehr geehrter Kunde, sehr geehrte Kundin, dieses Gerät stimmt mit den gültigen europäischen Richtlinien und Normen bezüglich elektromagnetischer Verträglichkeit und elektrischer Sicherheit überein.

Die europäische Vertretung für die
JVCKENWOOD Corporation ist:
JVCKENWOOD Deutschland GmbH
Konrad-Adenauer-Allee 1-11
61118 Bad Vilbel
DEUTSCHLAND

FOR EUROPE

WARNING

This is a Class A product. In a domestic environment this product may cause radio interference in which case the user may be required to take adequate measures.

The plastics packaging bags may cause suffocation when they are covered over the head. Tear them open, and keep them away from the reach of infants and children by ensuring that they are disposed of properly.

■ Para Brasil**Informação sobre eliminação de baterias**

Este produto não deverá ser eliminado como lixo doméstico em geral. Devolva a bateria velha ao comerciante ou para a rede autorizada, para que seja devolvida ao fabricante ou importador. A reciclagem e eliminação de lixo em uma maneira adequada, ajudarão para preservar recursos, prevenindo, ao mesmo tempo, contra efeitos prejudiciais sobre a nossa saúde e o meio ambiente.

Para Retirar a Bateria Recarregável

Pressione botão e puxe a bateria para fora.

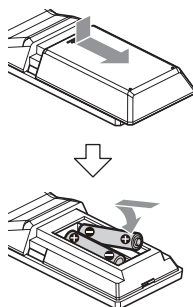

Consult your dealer as special technique is required when installing this product. Ensure that the fixing screws or nuts are tightened securely, otherwise, the unit may fall off.

Mounting to a firm place

As the unit contain parts rotating at high speed, mount it on a firm place with sufficient strength to support the vibration and weight of the unit.

Mass : Approx. 2.0 kg

If the strength is weak, the vibration will cause fuzzy images on the monitor screen. In the worst scenario, the camera may even fall off and hit somebody, resulting in serious accidents.

Mount the camera correctly

When mounting the unit to the ceiling, make sure to use a ceiling mounting bracket.

Be sure to connect the fall prevention wire (sold separately) and tighten the fixing screws or nuts securely.

Using the correct power and voltage

To supply power to this unit, use a DC 12 V or PoE+ (IEEE802.3at) power. Make use of the correct voltage.

Use the supplied AC adapter for the DC 12 V power supply. Do not use the supplied AC adapter on other devices.

Inspect the unit regularly

Screws may be loosened due to vibration or deterioration of the mounting section. Perform regular inspections for loosened screws and check whether there is any danger of the unit falling off.

Do not hang on this product, shake it, or hang objects over it. Applying an excessive load may cause the product to fall off and result in accidents.

Do not modify this product. It may result in accidents.

Do not place any object inside the product. Placing a metallic or inflammable object may cause a fire or shock hazard.

Contents

Getting Started

Safety Precautions	4
Contents	11
Main Features	13
Precautions	14
Names of Parts	17
Basic System Diagram	21

Installation/Connection

Mounting the Camera to the Ceiling Mount Bracket	22
Attaching Label to the Camera	22
Installing the Camera on the Ceiling	23
Installing the Camera on a Desktop	24
Attaching the Camera to a Tripod	24
Connecting the Cables	24
Network Features	25
Operating Environment	25
Checking the IP address	25
IP address settings	25
Confirming the Connection	26
Firmware Update	27

Using View Remote

View Remote Screen	28
Image	29
Video	32
Audio	34
System	34
Network	35
NDI Config 510N	37
Information	38

Shooting

Basic Shooting Procedures	39
Selecting the Video Output Resolution and Frame Rate	39

Connecting to the Network

Performing Live Streaming	40
---------------------------------	----

Menu Display and Detailed Settings

Menu Screen Hierarchical Chart	42
GUI Settings	43
Exposure	43
Color	45
Image	46
P/T/Z (P/T/Z)	46
Setup	47
Communication Setup	47
Video Settings	48
Restore Default	49

Camera Features

Auto-Tracking	50
Configuring Setup Files	51
Still Image Capture	52

Others

Troubleshooting	53
Specifications	54
Software License Agreement	57
Important Notice concerning the Software	58

Content of this Manual

Symbols used

- Caution** : Describes precautions concerning the operation of this product.
- Memo** : Describes reference information, such as functions and usage restrictions of this product.
-  : Indicates the reference page numbers and reference items.
- 510N** : Feature available on KY-PZ510NWU/KY-PZ510NWE/KY-PZ510NBU/KY-PZ510NBE only.

Content of this manual

- All rights reserved by JVCKENWOOD Corporation. Unauthorized duplication or reprinting of this manual, in whole or in part, is strictly prohibited.
- Illustrated designs, specifications and other contents of this manual are subject to change for improvement without prior notice.
- The terms HDMI and HDMI High-Definition Multimedia Interface, and the HDMI Logo are trademarks or registered trademarks of HDMI Licensing Administrator, Inc. in the United States and other countries.
- NDI is a trademark or registered trademark of Vizrt Group in the United States and other countries.
- macOS is a trademark of Apple Inc., registered in the U.S. and other countries.
- Google Chrome is a trademark and/or registered trademark of Google LLC.
- QR Code is a registered trademark of Denso Wave Incorporated.
- Microsoft and Windows are registered trademarks of Microsoft Corporation in the United States and other countries.
- Other product and company names included in this instruction manual are trademarks and/or registered trademarks of their respective companies. Marks such as ™ and ® have been omitted in this manual.

Main Features

| 4K Ultra HD

Equipped with a new-generation premium-quality high sensitivity CMOS sensor with a maximum number of 8.40 megapixels, this camera supports 4K (3840 x 2160)/50p, 60p output. It provides high resolution and smooth HDMI or IP video output. This 4K/50p, 60p output also supports H.264 or H.265. H.265 enables high-quality transmission in low bandwidth and H.264 enables transmission with a number of compatibilities.

| 80.0° Wide-angle Lens

Our first professional zoom lens with a horizontal angle of view of 80.0°. It enables shooting from a closer distance such as in a classroom or conference room. It is designed to completely suppress distortion and chromatic aberration.

| Supports the NDI5 streaming protocol 510N

Equipped with NDI|HX that enables video/audio transmission, low latency, and camera control with just a LAN cable. This mode also supports 4K 50p/60p.

| Auto-Tracking Function

This camera enables the tracking of a target person without using external control. With the recognition of the human body, face and head by AI, misidentification due to multiple people is minimized. In addition to lateral tracking, the camera is able to zoom and track a person moving away from it to obtain a close-up of the target person.

| Supports the SRT streaming protocol

With the packet loss support and encryption, the SRT protocol, which is ideal for live streaming via the Internet, is available at 4K 50/60p.

| Multi-camera Synchronization

This camera is able to obtain time information via NTP (Network Time Protocol) and superimpose it on the streaming data to create a multi-camera synchronization solution for live music events, etc. A compatible decoder is required for synchronous playback.

| USB Video Class

This camera can be used as a USB camera by connecting the USB Type-C terminal as the camera output to a PC. Enables up to 4K 30p output.

| Front LCD

Equipped with a display device on the front to tell the output mode and IP address readily.

| Remote Control Unit

This camera can be controlled using the industry standard protocol (IP/serial). It also comes with a user-friendly large infrared remote control to facilitate on-site camera control. Fine-grained control over the camera is also available with our dedicated IP protocol.

| Supports PoE+

In addition to the usual AC adapter, this camera supports PoE + that provides power via a LAN cable.

Precautions

Installation Location

- Be sure to install the camera horizontally.

Storage and Usage Locations

- Allowable ambient temperature and humidity
Be sure to use this unit within the allowable temperature range of 0 °C to 40 °C (32 °F to 104 °F) and a relative humidity of 30 % to 80 %. Using this unit at a temperature or humidity outside the allowable ranges could result not only in malfunction but also serious impact on the CMOS elements as small white spots may be generated. Please exercise care during use.
- Strong electromagnetic waves or magnetism
Noise may appear in the picture or audio and/or the colors may be incorrect if this unit is used near a radio or television transmitting antenna, in places where strong magnetic fields are generated by transformers, motors, etc., or near devices emitting radio waves, such as transceivers or cellular phones.
- Use of wireless microphone near this unit
When a wireless microphone or wireless microphone tuner is used near this unit during recording, the tuner could pick up noise.
- Inadequate heat ventilation may result in malfunction of this product. Be sure not to block vents around the product. This product discharges heat from the surface of the main unit.
- Do not install it at locations directly subjected to cold air such as near the vents of air-conditioners or at locations with high temperature.
- Avoid using or placing this unit in the following places.
 - Locations beyond the allowable operating humidity range of 30 %RH to 80 %RH. (Condensation is not allowed)
 - Near equipment that emits strong magnetic fields, such as transformers or motors.
 - Near equipment that emits radio waves, such as transceivers and mobile phones.
 - Locations with excessive dust and sand.
 - Locations that are subject to vibration such as inside the car or ship.
 - Locations prone to moisture such as window side.
 - Locations subject to steam or oil, such as kitchens.
 - Special environment, such as those with combustible atmosphere.
 - Locations that are subjected to radiation, X-rays, salt attack or corrosive gases.
 - Locations where chemicals are used such as swimming pools.
 - Hot or cold places that are beyond the allowable ambient operating temperature range.

Transportation

- Do not throw away the original box of the unit. Keep it and use it for transporting the unit in future.

Carrying the Camera

- Do not drop or hit this unit against a hard object when transporting.
- Remove the connecting cables when transporting the unit.
- When transporting the unit, turn off the power of the system.
- Pack the unit with cushioning material so as to avoid shock when transporting.
- Handle the unit with care and do not subject it to vibration or shock.

Power Saving

- If the camera is not to be used for a long time, turn off the power of the system for safety and energy conservation reasons.

Maintenance

- Turn off the power before performing any maintenance.
- Wipe the external cabinet of the unit with a soft cloth. Do not wipe the body with benzene or thinner. Doing so may cause the surface to melt or turn cloudy. When it is extremely dirty, soak the cloth in a solution of neutral detergent, wipe the body with it, and then use a clean cloth to remove the detergent.

License Notices

- **MPEG LA AVC**
THIS PRODUCT IS LICENSED UNDER THE AVC PATENT PORTFOLIO LICENSE FOR THE PERSONAL USE OF A CONSUMER OR OTHER USES IN WHICH IT DOES NOT RECEIVE REMUNERATION TO
(i) ENCODE VIDEO IN COMPLIANCE WITH THE AVC STANDARD ("AVC VIDEO") AND/OR
(ii) DECODE AVC VIDEO THAT WAS ENCODED BY A CONSUMER ENGAGED IN A PERSONAL ACTIVITY AND/OR WAS OBTAINED FROM A VIDEO PROVIDER LICENSED TO PROVIDE AVC VIDEO.
NO LICENSE IS GRANTED OR SHALL BE IMPLIED FOR ANY OTHER USE. ADDITIONAL INFORMATION MAY BE OBTAINED FROM MPEG LA, L.L.C. SEE [HTTP://WWW.MPEGLA.COM](http://www.mpegla.com)

Copyright

- Any recordings made on this camera that are played back for profit or public preview may infringe on the rights of the owner of the recordings.
Do not use the recordings for purpose other than personal enjoyment without prior consent from the owner. And even for personal enjoyment, you may not be able to record without permission from the owner.

Login Password

- The default password is widely known. It is very dangerous to use the password without changing it. Set a password that is not easily guessed. It is also recommended to change the password regularly.

Others

- This camera will perform the initial operation of pan/tilt/zoom upon powering on.
- The camera body may be captured in the recording depending on the pan, tilt or zoom position.
- Do not subject the lens to strong light source such as sun rays. This may cause the equipment to malfunction.
- During audio input or when using the mic, noise may occur when the rotation mechanism is rotated horizontally/vertically, when zooming is performed or when the power is turned on/off. This is not a malfunction.
- The pan operation range of this product is limited to $\pm 162.5^\circ$. Regardless of the function, operation is not possible beyond this range.
- Some switching hubs of products that are equipped with intelligent features may include a broadcast/multicast suppression function. Viewing of multicast images on this product may fail if this function is enabled.
- The dark areas on the screen may appear grainy or white spots may increase. When switching between color and black-and-white images, the brighter area on the screen is emphasized, which may reduce the visibility. However, this is not a malfunction.
- If the power supply voltage is momentarily cut off or reduced due to lightning or turning on of the air conditioner's power, the image may be disrupted or noise interference may occur.
- When shooting objects with a luminance difference or near a light source, ghost may occur on the screen. This is a feature of the built-in lens, and is not a malfunction.
- When the monitor in use has a wide display area, lines may appear at the peripheral area of the screen.
- Operation via an infrared remote control unit may not work depending on where and how the camera is installed.

- An afterimage can appear if you view a moving object on the monitor output, however this is not a malfunction.
- Do not put anything into the camera unit.
Metal and flammable items entering from the connectors can result in fire or electric shock.
- The camera may not show stable pictures for a few seconds immediately after the power is turned on, but this is not a malfunction.
- Do not drop this unit or subject it to strong impact or vibration as it is a precision equipment.
- Optical performance of lens
Due to the optical performance of the lens, color divergence phenomena (magnification chromatic aberration) may occur at the periphery of the image. This is not a camera malfunction.
- Noise may appear in the image when switching modes.
- Use the supplied AC adapter for the power supply (DC 12 V). Do not use the supplied AC adapter on other devices.
- Use the supplied power cord. And do not use the supplied power cord for any other devices.

- Before starting an important recording, be sure to perform a test recording in order to confirm that a normal recording is possible.
- We shall not be liable for the loss of recordings or opportunities in the event that recording could not be performed due to a problem that arises during the use of the video camera or recorder.

Names of Parts

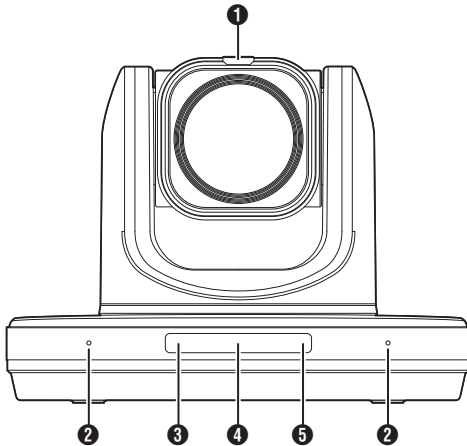

- ❶ Tally lamp
Light turns on or goes off during external control. Turns on/off according to the menu setting and blinks depending on the status of this camera.
- ❷ Built-in microphone
You can configure the menu settings to make use of the built-in microphone.
(☞ P34 [Input Type])
- ❸ STANDBY lamp
Lights up in green during standby.
- ❹ Information display
Displays information on the camera settings.
- ❺ POWER lamp
Lights up in blue when the power is turned on.

Terminal Section

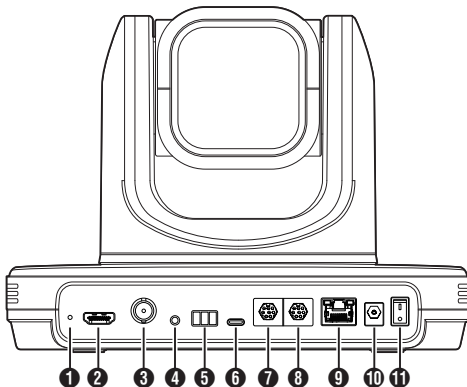

❶ RESTORE switch (Reset switch)

Memo : _____

- Press and hold down to activate reset.

❷ HDMI terminal

❸ 3G-SDI terminal

❹ LINE IN terminal

❺ RS485 terminal

- Half duplex mode
- Baud rate:
2400/4800/9600/38400 bps
- Start position: 1 bit
- Data bit length: 8 bits
- Stop bit length: 1 bit
- Check digit: None

❻ USB 2.0 terminal

❼ RS232 OUT terminal

❽ RS232 IN terminal

RS232 communication control

The serial port parameters are as follows.

- Half duplex mode
- Baud rate:
2400/4800/9600/38400 bps
- Start position: 1 bit
- Data bit length: 8 bits
- Stop bit length: 1 bit
- Check digit: None

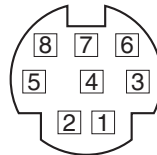

RS-232C IN		RS-232C OUT	
Pin Number	Signal Name	Pin Number	Signal Name
1	DTR_IN	1	DTR_OUT
2	DSR_IN	2	DSR_OUT
3	TXD_IN	3	TXD_OUT
4	GND	4	GND
5	RXD_IN	5	RXD_OUT
6	GND	6	GND
7	IR_OUT	7	NC
8	NC	8	NC

Corresponding Pins between Camera and Windows DB-9

Camera	Windows DB-9
1.DTR	1.CD
2.DSR	2.RXD
3.TXD	3.TXD
4.GND	4.DTR
5.RXD	5.GND
6.GND	6.DSR
7.IR OUT	7.RTS
8.NC	8.CTS
	9.RI

Corresponding Pins between Camera and Mini DIN

Camera	Mini DIN
1.DTR	1.DTR
2.DSR	2.DSR
3.TXD	3.TXD
4.GND	4.GND
5.RXD	5.RXD
6.GND	6.GND
7.IR OUT	7.NC
8.NC	8.NC

- ⑨ LAN(PoE+) terminal
- ⑩ DC 12V terminal
- ⑪ Power switch

Infrared Remote Control

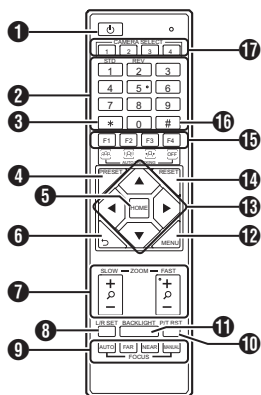

- 1** STANDBY button
Switches between the standby and normal modes.
- 2** NUMBER button
For preset configuration or invoking a preset number.
- 3** * button
To be used together with other buttons.
- 4** PRESET button
Stores the preset position.
[PRESET] + NUMBER button (1 to 9):
Stores the preset position in the selected NUMBER button.

Memo : _____

- Press the buttons above in sequence.

- 5** HOME button
Restores the orientation of the camera to face the front.
Functions as a confirmation button when the menu is displayed.
- 6** RETURN button
Functions as a cancel button when the menu is displayed.
- 7** ZOOM button
SLOW ZOOM:
Zooms in [+] or zooms out [-] the camera at a low speed.
FAST ZOOM:
Zooms in [+] or zooms out [-] the camera at a high speed.

- 8** L/R SET button
Press the button together with the NUMBER button [1] or [2] at the same time to pans the camera toward the left or right.
- Pressing the left or right side of the [L / R SET] + [1] (STD) at the same time pans the camera toward the left or right accordingly.
 - Pressing the left or right side of the [L / R SET] + [2] (REV) at the same time pans the camera toward the right or left accordingly. This setting comes in handy in cases such as when the camera is suspended from the ceiling.
- 9** FOCUS button
For adjusting the focus.
- [AUTO]:
Auto Focus mode (AF)
 - [MANUAL]:
Manual Focus mode (MF)
 - During MF, focus is adjusted using [FAR] (for setting focus on a distant subject) and [NEAR] (for setting focus on a nearby subject).

- 10** P/T RST button
Resets the pan and tilt positions.

- 11** BACKLIGHT button
Press the button to enable backlight compensation. Pressing the button again disables backlight compensation.

Memo : _____

- This feature is available only when [Exposure] is configured to "Auto".
- Use this feature when there is a light source behind the subject that causes the subject to appear dark in the image.

- 12** MENU button
Displays the menu or exits the menu display.
- 13** PAN/TILT CONTROL button
Press the arrow button to pan or tilt the camera. Pressing the [HOME] button restores the orientation of the camera to face the front. Moves the cursor when the menu is displayed.
- 14** RESET button
Erases the preconfigured settings.
[RESET] + NUMBER button (0 to 9):
Erases the preset position in the selected NUMBER button.
[*] + [#] + [RESET]:
Erases all the preset positions.

Memo : _____

- Press the buttons above in sequence.

15 IR REMOTE CONTROL, AUTO TRACKING buttons

• IR REMOTE CONTROL

For configuring the number of the camera you want to control using the infrared remote control.

- [*] + [#] + [F1]: Address 1
- [*] + [#] + [F2]: Address 2
- [*] + [#] + [F3]: Address 3
- [*] + [#] + [F4]: Address 4

Memo : _____

- Press the buttons above in sequence.

• AUTO TRACKING

Configuring this settings enables the camera to lock on to a target and perform auto tracking. Press the F3 button to start and the F4 button to exit.

(P5 P50 [Auto-Tracking])

16 # button

To be used together with other buttons.

17 CAMERA SELECT button

Press the number of the camera you want to control using the infrared remote control.

Memo : _____

- The remote control unit makes use of 2 AAA dry-cell batteries.
- Make sure to load the battery in the correct +/- orientation.

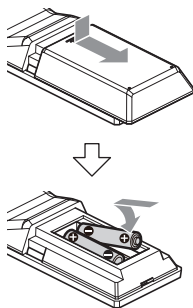

Caution : _____

- Do not place the remote control at a location that is subject to high temperature. Otherwise, the remote control may be deformed, thus resulting in malfunction.
- Place the batteries at a location that is out of reach of children. In the event that the battery is swallowed by mistake, consult a doctor immediately.
- Do not throw the batteries into fire or place them at a location that is subject to high temperature. Otherwise, the batteries may explode.
- When replacing the batteries, use ones that are of the same model or type. Using a different type of battery may cause it to explode.

Shortcut settings

[*] + [#] + [1]:

Configures the menu language to English.

[*] + [#] + [3]:

Configures the menu language to Chinese.

[*] + [#] + [4]:

Displays the current IP address.

[*] + [#] + [6]:

Resets all menu settings to the default values.

[*] + [#] + [8]:

Displays the camera version.

[*] + [#] + [9]:

Flips the video image horizontally or vertically.

[*] + [#] + [MANUAL]:

Resets the IP address to the default value.

Memo : _____

- Press the buttons above in sequence.

Basic System Diagram

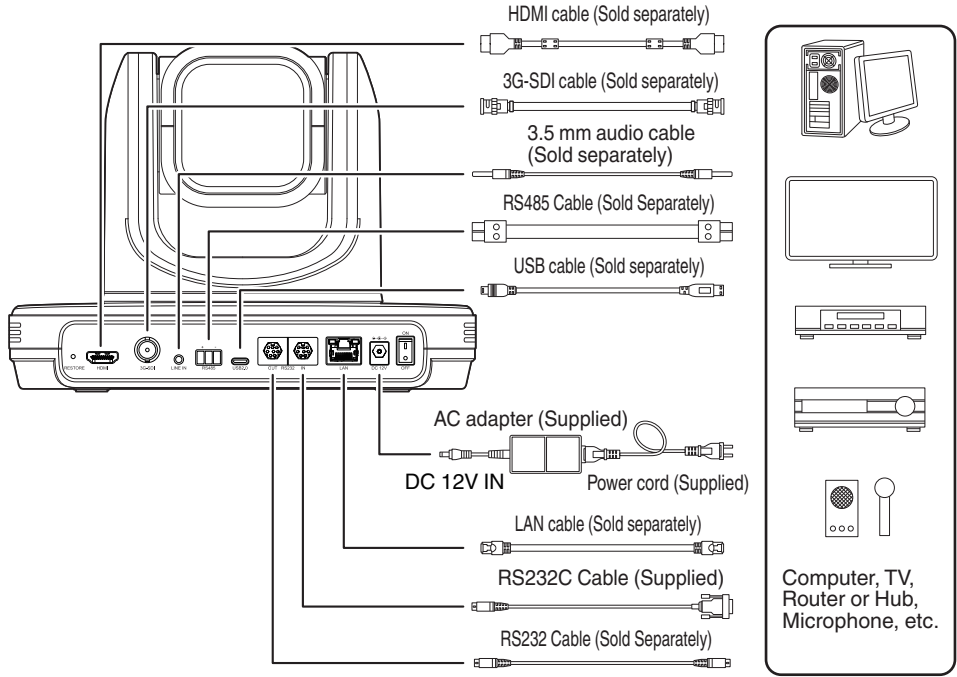

Quick Start

- 1 Check to ensure that the connections are correct before turning on the power.
- 2 Connect the AC adapter to the DC 12 V terminal. Turn on the power switch.
- 3 Initialization is activated after the camera is powered on. The camera lens moves to both the horizontal and vertical limit positions. Initialization is complete after it has moved back to the front view position.

Memo : _____

- Operation is possible when the light of the STANDBY lamp has turned off.
- If Preset 1 is preconfigured, the camera will move to the Preset 1 position.

Use as a USB camera

This camera can be used as a USB camera by connecting the USB2.0 port to a PC using a USB2.0-compatible cable (sold separately).

Memo : _____

- Streaming from the camera will not take place while it is connected to a PC via USB. To start video streaming, disconnect the USB connection with the PC and restart the camera.
- If the USB connection with the PC is disconnected, turn on the power of the camera again.
- To enable the Auto-Tracking Function on the USB camera, turn on the power of the camera after connecting the camera and the PC.

Mounting the Camera to the Ceiling Mount Bracket

- Be sure to put on protective glasses to protect your eyes from falling objects when mounting the camera.
- Be sure to place the base of the camera horizontally. The camera will not operate properly if it is slanted.

Memo : _____

- The ceiling mount bracket is not necessary when the camera is installed on a desktop or attached to a tripod.
- If necessary, make a hole ($\Phi 40$ mm) to route the connection cable and fall prevention wire (ceiling) into the ceiling.

Caution : _____

- The fall prevention wire (for ceiling) is not supplied. Make use of the wire while taking note of its length, strength, pull and material (insulation).
- Attach the fall prevention wire (ceiling) to a place with sufficient strength (ceiling slab, etc.).
- Take note of the length, strength, pull and material (insulation) of the fall prevention wire (for ceiling) and use one with a wire strength of 150 N (15 kg) or more.
- The inner diameter of the ring section of the fall prevention wire (ceiling) mounted on the camera should be above $\Phi 3$ mm but below $\Phi 4$ mm, the outer diameter should be $\Phi 9$ mm and below, and the thickness 2 mm and below.
- The camera does not come with mounting screws for attaching it to the ceiling. Make appropriate use of the M5 expansion screws (x4) according to the thickness of the ceiling.

1 Place the ceiling mounting bracket (ceiling side) against the ceiling and mark the mounting position on the ceiling.

Memo : _____

- Take note of the front direction of the camera when placing the marks.

2 Drill holes into the ceiling at the marked positions.

Memo : _____

- Insert a straw or toothpick into the mounting holes to determine the depth and required length of the screws.

3 Place the ceiling mounting bracket (ceiling side) against the ceiling again at the marked position.

4 Fasten the mounting bracket using the M5 expansion screws (sold separately).

Memo : _____

- Check that the screws are tighten securely when mounting is completed.

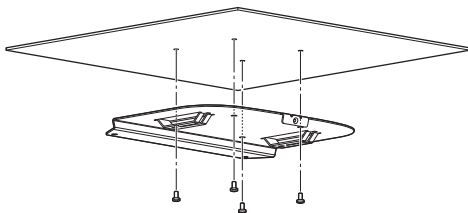

Attaching Label to the Camera

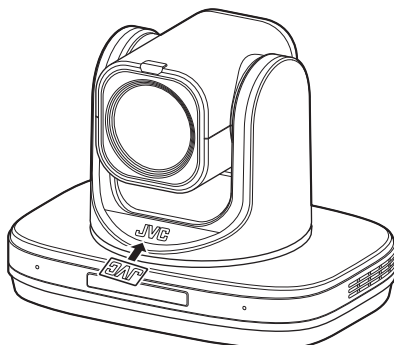

Before installing the camera to the ceiling, attach the JVC logo label as illustrated in the diagram.

- 1 Peel off the label backing.
- 2 Turn the label upside down.
- 3 Align the center position of "V" of the JVC logo on the camera with that on the label, followed by attaching the label.

Memo : _____

- If there is dust or dirt on the surface, remove accordingly before attaching the label.
- Make sure that the JVC logo label is not tilted when attaching.

Installing the Camera on the Ceiling

- 1 Remove the feet from the bottom surface of the camera.

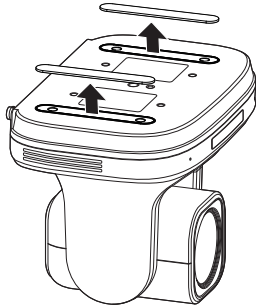

- 2 Use the four M3 screws that come with the camera to attach the ceiling mounting bracket (camera side) to the bottom surface of the camera.

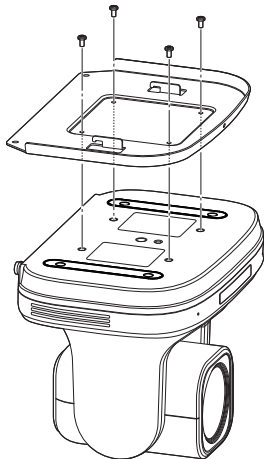

- 3 Mount the camera to the ceiling mount bracket (ceiling side).
Attach the hook on the ceiling mounting bracket (camera side) to the hole on the ceiling mounting bracket (ceiling side).

- 4 Use three M3 screws that come with the camera to attach.

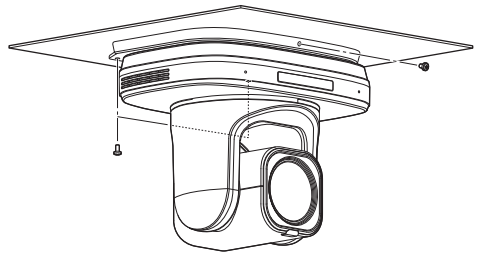

Fasten the drop prevention wire (sold separately) together with one of the screws.

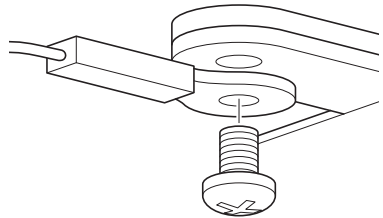

Connect the cables after these procedures.

Installing the Camera on a Desktop

- Place the camera on a flat surface.
- Be sure to place the base of the camera horizontally. The camera will not operate properly if it is slanted.

Memo : _____

- The use of ceiling mount bracket is not required.

Caution : _____

- Do not move the camera while the power of the system is on. Doing so may result in malfunctions or accidents.
- Do not hold the camera head while carrying the camera.

Connect the cables after these procedures.
--

Attaching the Camera to a Tripod

- Attach a tripod using the screw hole at the bottom of this product.
(1/4-20UNC, ISO1222 (6.35 mm))
- To prevent the camera from falling off, which may result in injuries or damages, read the "INSTRUCTIONS" of the tripod to be used and make sure that it is securely attached.
- To ensure proper pan/tilt operation, set the tripod such that the camera is parallel to the horizontal surface.

Memo : _____

- The use of ceiling mount bracket is not required.

Caution : _____

- If the camera exceeds the weight limit of the tripod, do not mount it on the tripod.
- Use the tripod on a stable surface.
- Use screws with a screw length between 4.5 mm and 7 mm.
- Do not install the camera at a high location when the camera is attached to a tripod.

Connect the cables after these procedures.
--

Connecting the Cables

1 Connect the cables.

- Connecting to an HDMI/SDI monitor allows you to check the camera images.
- To input the audio, connect the audio cable to the LINE IN terminal.

2 Connect the LAN cable.

- You can operate the camera from a web browser by connecting a LAN cable.

3 Connect the power cable.

- To supply power from an AC adapter, connect an AC adapter cable.
- To supply power via PoE+, do not connect the AC adapter cable.

4 After turning on the power switch, the POWER lamp lights up and initialization starts.

The camera lens moves to both the horizontal and vertical limit positions. Initialization is complete after it has moved back to the front view position.

Memo : _____

- Operation is possible when the light of the STANDBY lamp has turned off.
- If Preset 1 is preconfigured, the camera will move to the Preset 1 position.

Caution : _____

- Do not supply power through the AC adapter cable and LAN cable at the same time.

Warning

To supply power to this unit, use a DC 12 V or PoE+ (IEEE802.3at) power. Make use of the correct voltage.
Supplying a power beyond the rated value may result in failures, smoke or fire. If the camera breaks down, turn off the power and contact our service center immediately.
When a power beyond the rated value is supplied, the internal components may be damaged even if no abnormality is found on the appearance and operation of the camera. Please contact our service center immediately for servicing (charged separately).

Network Features

Operating Environment

Operation has been verified for the following environments.

- Computer
 - OS: Windows 10
Web browser: Google Chrome
 - OS : macOS 12.4
Web browser: Google Chrome

Checking the IP address

There are two ways to identify the IP address of the camera.

- ① Press *, # and the number 4 button on the remote control in sequence to display the IP address of the camera on the screen of the HDMI/SDI monitor connected to the monitor.
- ② Connect the camera to a PC using a network cable and run “upgrade_standard.exe” to search for the IP address.

Memo : _____

- Download the “upgrade_standard.exe” from the URL stated on the cover page.

IP address settings

There are two ways to configure the IP address of the camera.

- ① Log in to the web page, and select [Network] → [Lan Settings] to make changes to the IP address, subnet mask and gateway. Click “Submit” to restart the camera.
- ② Use “upgrade_standard.exe” to set the IP address.

1 Click the [Search] button.

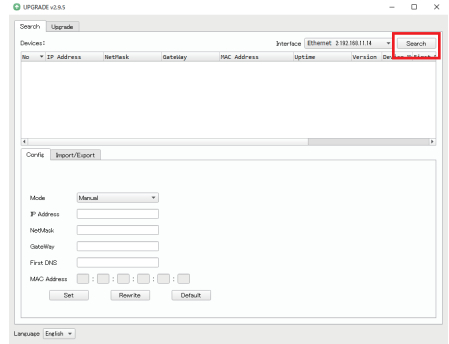

2 Select the IP address of the camera you want to change.

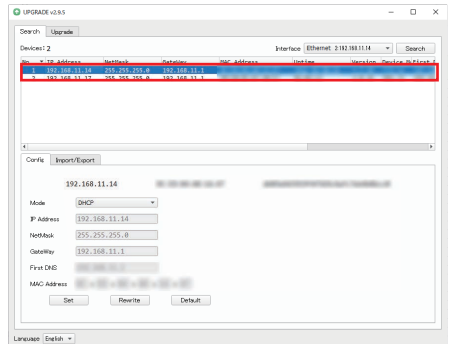

- 3 After changing the value of “IP Address”, “NetMask”, and “GateWay” is complete, click the [Set] button.

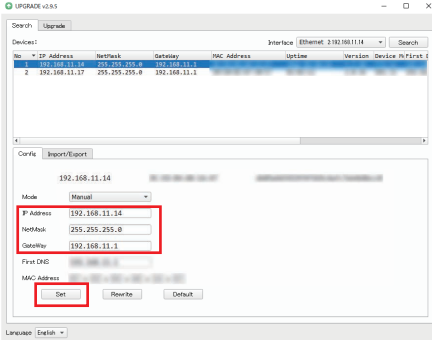

- When the setting is successful, the following display appears and the camera restarts.

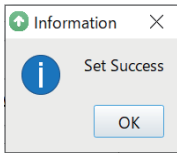

Confirming the Connection

- 1 Start up the web browser on the terminal you wish to connect to the camera, and enter the IP address in the address field. (Example: http://192.168.0.10)

Memo : _____

- The default IP address of camera is 192.168.0.10.

- 2 Enter the user name and password.

Enter the user name (jvc) and the password on the login screen to display the Live View screen.

Memo : _____

- A screen for changing the password is displayed when you log in for the first time and enter the default password (“0000”). Please change the password.

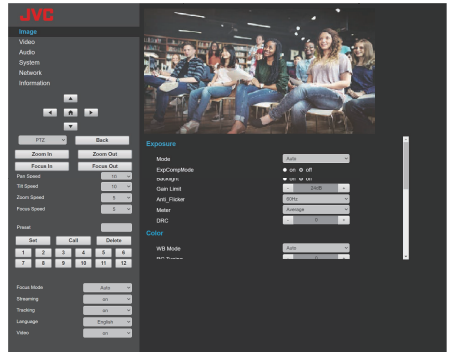

Firmware Update

Update the firmware of the camera from a Windows PC.

You are recommended to update the firmware to the latest version once it has been released to the public.

Memo : _____

- Download “upgrade_standard.exe” and the firmware update file from the URL link on the cover page of this manual.

- 1 **Connect the camera to a PC on the same network and run “upgrade_standard.exe” on the PC.**
- 2 **Click the [Search] button.**
Cameras connected on the same network are displayed.

- 4 **Click the [Query] button under the [Upgrade] tab.**
The current firmware version is displayed.
- 5 **Click the [Type] button and select “MTD”.**

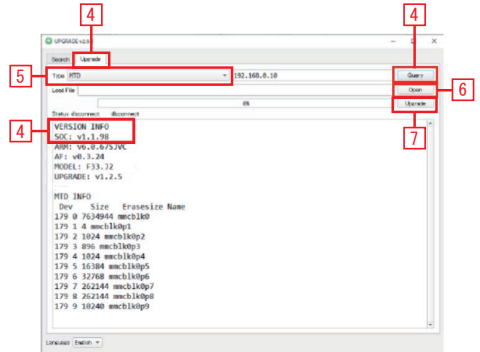

- 6 **Click the [Open] button and select the update file (.img file).**
- 7 **Click the [Upgrade] button.**
Update of the firmware starts.
Update is complete when “Upgrade Success” is displayed.
- 8 **After update is complete, press and hold the “RESTORE” switch on the terminal area at the back of the camera.**
The camera settings are initialized.

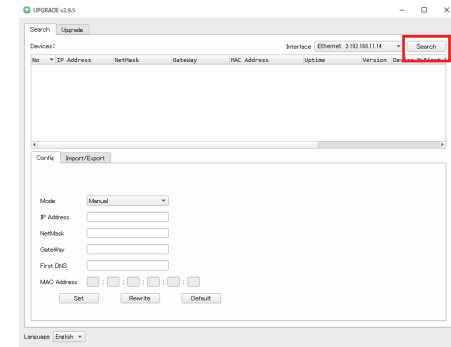

- 3 **Select the camera to update.**
Double-click to select.

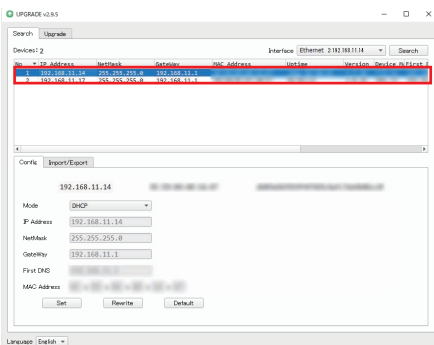

View Remote Screen

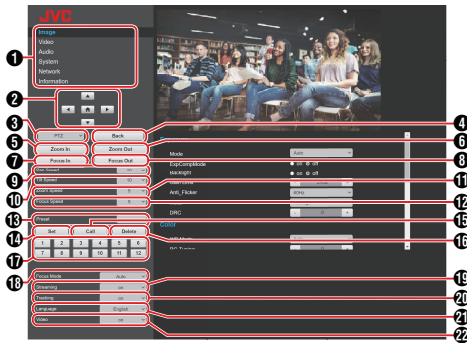

Memo : _____

- Some menu items may not be configurable depending on the operating mode and status of the camera.
- After changing the setting menu, the setting value may be initialized if the power is turned off before the saving is completed with the [Submit & Reboot] or [Submit] button.
- Depending on the camera condition, the actual setting value may not be reflected on the display of the View Remote screen. In this case, reload the web browser.

- 1** Settings menu selection switch
Displays the different settings menus.
Selecting "Image" displays the camera image.

Memo : _____

- Audio is not output.
- Supports full-screen display.
- To display the menu on the live screen, configure [Encode Codec] of [First stream] or [Second stream] to "H.264". If the menu display is too small, decrease the [Resolution] for [First stream] or [Second stream] accordingly.

- 2** Pan/tilt, menu control and HOME buttons
Moves the camera in one of the ◀▶▲▼ directions.
Pressing the HOME button restores the pan, tilt and zoom positions to the default setting.
If the camera menu is open, move the cursor using ◀▶▲▼, followed by pressing the HOME button to confirm.

Memo : _____

- Selecting "OSD" at **4** Pan/tilt operation/ Camera menu call-up enables camera menu operation. Selecting "PTZ" enables the camera operation.

- 3** Pan/tilt operation/ Camera menu call-up
Selecting "OSD" displays the camera menu on the live video of the web browser, streaming video and HDMI (SDI) screen.
You can use the buttons at **2** to move the menu cursor and to confirm your selection. Selecting "PTZ" closes the camera menu. You can pan and tilt using the buttons at **2**.

- 4** Back button
Returns to the next higher level in the menu during menu operation.
- 5** Zoom In button
Moves the zoom toward the Tele-end.

- 6** Zoom Out button
Moves the zoom toward the Wide-end.
- 7** Focus In button
Moves the focus toward the Tele-end when the camera is in the manual focus mode.
- 8** Focus Out button
Moves the focus toward the Wide-end when the camera is in the Manual Focus mode.
- 9** Horizontal speed control
For configuring the speed of horizontal movement.
[Setting Values: 1 to ● 10 to 24]
- 10** Vertical speed control
For configuring the speed of vertical movement.
[Setting Values: 1 to ● 10 to 20]

- 11** Zoom speed control
For specifying the zooming speed.
[Setting Values: 1 to ● 5 to 7]
- 12** Focus speed control
For setting the focusing speed.
[Setting Values: 1 to ● 5 to 7]
- 13** Preset number
After setting the preset number, pressing the **14** Preset button saves the pan, tilt or zoom position and pressing the **15** Preset Call button pans, tilts or zooms to the position that was saved.
[Setting Values: 1 to 255]

- 14** Preset button
Saves the current pan/tilt/zoom position to the preconfigured preset number.
- 15** Preset Call button
Calls up the corresponding pan/tilt/zoom position using a preset number.

Memo : _____

- The camera will not move if a pan/tilt/zoom position is not stored in the selected preset number.

- 16** Preset Delete button
Deletes the information of the pan, tilt or zoom position that has been configured to the preset number.
- 17** Direct preset number
Moves to the preset number directly with one action.
Pressing 1 moves the camera lens to Preset number 1.
- 18** Focus mode
Switches between Auto Focus and Manual Focus.
- 19** Streaming button
Switches streaming to on or off.
- 20** Tracking button
Switches the Auto-Tracking to on or off.

Memo : _____

You can also start and stop tracking from the View Remote screen

- Start tracking: Set the Tracking button to “on”.
- Stop tracking: Set the Tracking button to “off”.
( P50 [Auto-Tracking])

- 21** Language button
For configuring the display language on the web screen.

[Setting Values: ●English, Français, Deutsch, Italiano, Español, Русский, 中文(簡), 日本語]

- 22** Video
Setting this button from “off” to “on” restores the position of Preset number 1 and outputs the camera image. (The camera enters into video on mode.)
Setting this button from “on” to “off” moves the pan/tilt position to the rear facing down and stops the camera image output. (The camera enters into video off mode.)

Image

This is the setting for adjusting the image quality.

Memo : _____

- To display the menu on the camera’s video image, configure [Encode Codec] of [First stream] or [Second stream] to “H.264”. If the menu display is too small, decrease the [Resolution] for [First stream] or [Second stream] accordingly.

Exposure

↳ Mode

For selecting the method for controlling the exposure.

- Auto
Gain/Shutter/Iris are adjusted automatically.
- Manual
Gain/Shutter/Iris operate according to the menu setting.
- SAE
Shutter speed is configured according to the setting in the [Shutter] menu, while gain and iris is automatically adjusted.
- AAE
Iris is configured according to the setting in the [Iris], while gain and shutter speed are automatically adjusted.
- Bright
Adjusts the brightness of the RAW data.

[Setting Values: ●Auto, Manual, SAE, AAE, Bright]

↳ ExpCompMode

Performs exposure compensation when this is configured to on.

[Setting Values: on, ●off]

Memo : _____

- This item can be configured when [Mode] is set to “Auto”.

↳ ExpComp

Adjusts the exposure compensation value.

[Setting Values: -7 to +7 (●0)]

Memo : _____

- This item can be configured when [ExpCompMode] is set to “on”.

↳ Backlight

For configuring backlight compensation.

[Setting Values: on, ●off]

Memo : _____

- This item can be configured when [Mode] is set to "Auto".

↳ Bright

Adjusts the brightness.

[Setting Values: 0 to 17 (●7)]

Memo : _____

- This item can be configured when [Mode] is set to "Bright".

↳ Gain

This function electrically boosts the light sensitivity when there is insufficient illumination on the object. You can set the gain of the video amplifier according to the brightness of the object.

[Setting Values: ●0dB, 3dB, 6dB, 9dB, 12dB, 15dB, 18dB, 21dB, 24dB, 27dB, 30dB, 33dB, 36dB, 39dB, 42dB, 45dB]

Memo : _____

- This item can be configured when [Mode] is set to "Manual".

↳ Shutter

For configuring the shutter speed.

- For "60Hz"[Video Format]
[Setting Values: 1/30, ●1/60, 1/90, 1/100, 1/125, 1/180, 1/250, 1/350, 1/500, 1/725, 1/1000, 1/1500, 1/2000, 1/3000, 1/4000, 1/6000, 1/10000]
- For "50Hz"[Video Format]
[Setting Values: 1/25, ●1/50, 1/75, 1/100, 1/120, 1/150, 1/250, 1/350, 1/500, 1/725, 1/1000, 1/1500, 1/2000, 1/3000, 1/4000, 1/6000, 1/10000]

Memo : _____

- This item can be configured when [Mode] is configured to "Manual" or "SAE".
- "1/30" can be selected when frame rate is configured to 30p/29.97p, and "1/25" can be selected when frame rate is configured to 25p. (P39 [Selecting the Video Output Resolution and Frame Rate])

↳ Iris

For configuring the iris value (F number).

[Setting Values: ●F1.8, F2.0, F2.4, F2.8, F3.4, F4.0, F4.8, F5.6, F6.8, F8.0, F9.6, F11.0, Close]

Memo : _____

- This item can be configured when [Mode] is configured to "Manual" or "AAE".

↳ Gain Limit

For setting the maximum value of the operation that automatically switches the gain boost level according to the brightness.

[Setting Values: 3dB, 6dB, 9dB, 12dB, 15dB, 18dB, 21dB, 24dB, ●27dB, 30dB, 33dB, 36dB, 39dB, 42dB, 45dB]

Memo : _____

- This item can be configured when [Mode] is configured to "Auto", "SAE", "AAE" or "Bright".

↳ Anti-Flicker

For correcting video image flicker that occurs under a fluorescent light.

[Setting Values: 50Hz, ●60Hz, off] (U model)

[Setting Values: ●50Hz, 60Hz, off] (E model)

Memo : _____

- This item can be configured when [Exposure] is configured to "Auto", "AAE" or "Bright".

↳ Meter

Shutter speed, iris (F number) and ISO speed are controlled to adjust the exposure to an appropriate level according to the brightness of the subject in the [Mode] settings. Use this setting to configure the method of compensation in this case.

[Setting Values: ●Average, Center, Smart, Top]

Memo : _____

- This item can be configured when [Mode] is configured to "Auto", "SAE", "AAE" or "Bright".

↳ DRC

Adjusts the intensity of DRC.

[Setting Values: 0 to 8 (●0)]

Color**↳ WB Mode**

For setting the white balance mode.

- Auto
The white balance is automatically adjusted according to the color temperature changes of the lighting that is currently used to illuminate the subject.
- Indoor
For configuring to a color temperature that is suitable for indoor shooting.
- Outdoor
For configuring to a color temperature that is suitable for outdoor shooting.
- Manual
Enables adjustment of the color temperature using R gain and B gain.
- OnePush
Selecting “OnePush” and pressing the [●] button adjusts the white balance according to the color temperature of the lighting that is currently used to illuminate the subject.

[Setting values: ●Auto, Indoor, Outdoor, Manual, OnePush]

↳ R Gain

Adjusts the R (red) gain in the Manual mode.

[Setting Values: 0 to 255 (●61)]

Memo : _____

- This item can be configured when [WB Mode] is set to “Manual”.

↳ RG Tuning

Fine-tunes the R (red) component.

[Setting Values: -10 to +10 (●0)]

Memo : _____

- This item can be configured when [WB Mode] is set to “Auto”.

↳ B Gain

Adjusts the B (blue) gain in the Manual mode.

[Setting Values: 0 to 255 (●67)]

Memo : _____

- This item can be configured when [WB Mode] is set to “Manual”.

↳ BG Tuning

Fine-tunes the B (blue) component.

[Setting Values: -10 to +10 (●0)]

Memo : _____

- This item can be configured when [WB Mode] is set to “Auto”.

↳ Saturation

For adjusting the saturation.

[Setting Values: 60% to 200% (●100%)]

↳ Hue

For adjusting the hue.

[Setting Values: 0 to 14 (●7)]

Image

↳ Brightness

For adjusting the brightness.

[Setting Values: 0 to 14 (●7)]

* When [Style] is set to a value other than “Bright”

[Setting Values: 0 to 14 (●8)]

* When [Style] is set to “Bright”

↳ Contrast

For adjusting the contrast.

[Setting Values: 0 to 14 (●7)]

* When [Style] is configured to “Default” or “Norm”

[Setting Values: 0 to 14 (●9)]

* When the [Style] item is configured to “Bright” or “PC”

↳ Sharpness

Adjusts the outline correction value.

[Setting Values: 0 to 11 (●6)]

* When [Style] is configured to “Default” or “Norm”

[Setting Values: 0 to 11 (●7)]

* When the [Style] item is configured to “Bright” or “PC”

↳ Flip-H

Flips the video image in the horizontal direction.

[Setting Values: on, ●off]

↳ Flip-V

Flips the video image in the vertical direction.

[Setting Values: on, ●off]

↳ B&W Mode

Switches the video to a grayscale display.

[Setting Values: on, ●off]

↳ Style

For configuring the picture quality adjustment mode.

[Setting Values: ●Default, Norm, Bright, PC]

Memo : _____

- The settings will not be reset even when you press the RESTORE switch.

↳ NR3D-Level

For configuring 3D noise reduction.

[Setting values: off, 1 to 8 (●6), Auto]

Video

This is the setting screen for the HDMI/SDI terminal and streaming video.

After configuring the items, press the [Submit & Reboot] or [Submit] button.

The settings will be applied when the camera is next restarted.

Video Settings

↳ HDMI/SDI Output

For selecting the video output destination.

[Setting values: SDI, ●HDMI]

↳ Video Format

For configuring the video format.

- When the video output is “HDMI”

[Setting values: 3840x2160/60p, 3840x2160/59.94p, 3840x2160/50p, 3840x2160/30p, 3840x2160/29.97p, 3840x2160/25p,

1920x1080/60p, 1920x1080/59.94p, 1920x1080/50p, 1920x1080/60i, 1920x1080/59.94i, 1920x1080/50i, 1920x1080/30p, 1920x1080/29.97p, 1920x1080/25p, 1280x720/60p, 1280x720/59.94p, 1280x720/50p]

- When the video output is “SDI”

[Setting values: 1920x1080/60p, 1920x1080/59.94p, 1920x1080/50p, 1920x1080/60i, 1920x1080/59.94i, 1920x1080/50i, 1920x1080/30p, 1920x1080/29.97p, 1920x1080/25p, 1280x720/60p, 1280x720/59.94p, 1280x720/50p]

[Default Value: 1920x1080/59.94p] (U model)

[Default Value: 1920x1080/50p] (E model)

Setup Type

For selecting the method to configure the streaming video.

[Setting Values: Recommended, ●Manual]

↳ Video Format

For selecting the streaming frame rate.

[Setting Values: UHD/2160p, ●FHD/1080p, HD/720p]

Memo : _____

- Available when [Setup Type] is set to “Recommended”.

↳ Bandwidth

For selecting the streaming bandwidth.

[Setting Values: High, Medium, ●Low]

Memo : _____

- Available when [Setup Type] is set to “Recommended”.

First Stream, Second Stream

RTSP and RTMP(S) allow simultaneous streaming of videos in the First Stream and Second Stream settings.

Memo : _____

- Available when [Setup Type] is set to “manual”.

↳ Encode Codec

For selecting the streaming video codec.

[Setting Values: ●H.264, H.265, MJPEG]

Memo : _____

- Select “H.264” or “H.265” when [Resolution] (first stream) is set to “3840x2160”.

↳ Resolution

For selecting the streaming video resolution.

[Setting Values (First Stream): 3840x2160, ●1920x1080, 1280x720, 1024x576, 720x480, 720x408, 640x480, 640x360]

[Setting Values (Second Stream): 720x480, 720x408, 640x480, ●640x360, 480x320, 320x240]

Memo : _____

- When [Video Settings]→[Video Format] is set to “3840x2160/60p”, “3840x2160/59.94p” or “3840x2160/50p”, “3840x2160” cannot be selected.

↳ Frame Rate

For configuring the streaming video frame rate.

[Setting Values: 1 to 60]

Memo : _____

- To configure [Frame Rate] to “60fps” or “50fps” when [Resolution] is set to “3840x2160”, configure [Video Settings]→[Video Format] to a value other than “3840x2160/**p”.

↳ Bit Rate

For configuring the bitrate of the video stream when [Encode Codec] is configured to “H.264” or “H.265”.

[Setting Values (First Stream): 32 to 61440

(●8192)]

[Setting Values (Second Stream): 32 to 20480

(●1024)]

↳ Qfactor

For configuring the Q value when [Encode Codec] is configured to “MJPEG”.

[Setting values: 1 to 99 (●80)]

↳ I Key Frame Interval

Performs encoding with the I-frame as the starting point.

Lowering the value to shorten the interval helps to maintain a stable picture quality even when there are rapid changes in the video image. However, the picture quality for video images with little change will deteriorate.

[Setting Values: 2 to 60]

↳ Bit Rate Control

For selecting Constant Bitrate (CBR) or Variable Bitrate (VBR).

[Setting values: ●CBR, VBR]

Advanced Settings

↳ Encode Level

For selecting a streaming video encoding level.

[Setting Values: ●mainprofile, highprofile]

Memo : _____

- If [Encode Codec] for [First Stream] or [Second Stream] is configured to “H.265”, the setting is fixed at “mainprofile”.

Audio

This is the setting screen for the HDMI terminal, SDI terminal and streaming audio. After configuring the items, press the [Submit& Reboot] or [Submit] button. The settings will be applied when the camera is next restarted.

Audio Settings

↳ Audio Switch

Configuring this item to “on” enables audio input from the LINE IN terminal (LINE IN) or the built-in microphone (MIC).

[Setting Values: ●on, off]

Memo : _____

- This setting remains valid when the camera is connected to a PC via USB.

↳ Sample Rate

For configuring the sampling rate. Fixed at “48K”.

↳ Bit Rate

For configuring the bitrate.

[Setting Values: ●96K, 128K]

↳ Input Type

For setting the audio input method.

[Setting values: ●LINE IN, MIC]

↳ Input Vol

For configuring the volume of the audio input.

[Setting Values: 0 dB to 59 dB (●20 dB)]

↳ ADTS Options

For configuring the ADTS option.

[Setting Values: on, ●off]

System

For restarting the system and management of users.

Initialize

↳ Reboot

Restarts the camera. Use this function to apply new video or audio settings.

User

↳ UserName

User name for accessing the camera from the web browser.

Fixed at “jvc”.

↳ Passwd

For configuring the password for accessing the camera from a web browser.

Memo : _____

- The password cannot be configured to the default password value (0000).

Restore Default

After initializing the settings, all settings such as the IP address will be restored to the factory default settings. After the initialization, it is necessary to close the browser and reconnect.

Network

For configuring network-related settings. After configuring the items, press the [Submit & Reboot] or [Submit] button. The settings will be applied when the camera is next restarted.

SRT Settings

Configuring it to “on” and pressing the [Submit & Reboot] button starts SRT streaming after the camera is restarted.

[Setting Values: on, off]

↳ SRT Mode

For configuring the SRT connection mode. [Setting values: Caller, Listener, Rendezvous]

↳ SRT Server

For setting the address of the SRT server. The default value is 192.0.2.1.

Memo : _____

- This item can be configured when [SRT Mode] is set to “Caller” or “Rendezvous”.

↳ SRT Port

For configuring the SRT port for use during live streaming. The default value is “4578”.

↳ SRT Encryption

For configuring SRT encryption. [Setting values: None, AES-256, AES-192, AES-128]

↳ SRT Password

For configuring the SRT password. You can enter up to 10 to 15 characters. The default value is “1234567890”.

↳ SRT Bandwidth Overhead

Enter the SRT bandwidth overhead using an integer between 5% and 100%. The default value is “25%”.

↳ SRT Latency

Enter the amount of SRT latency using an integer between 20 ms and 8000 ms. The default value is “500ms”.

↳ SRT FEC

For configuring the FEC mode. It enables recovery of data streaming packet loss without retransmission. [Setting values: 6x6, 8x8, 10x10, off]

↳ SRT StreamId

For setting the registered stream ID of the live distribution destination. It allows direct streaming of multiple cameras on a single device.

- * You can enter up to 50 characters.

Memo : _____

- Input and change are possible only when [SRT Mode] is configured to “Caller”.

RTSP Settings

↳ RTSP Port

For configuring the RTSP port. The default value is “554”.

↳ RTSP Auth

Configuring to “on”, the user name and password are required to receive streaming. [Setting Values: on, off]

RTMP(S) Settings

↳ First Stream

For configuring the RTMP(S) First Stream video. Configure the setting to “on” for streaming and press the [Submit & Reboot] button. RTMP(S) streaming will start after the camera is restarted. [Setting values: on, off]

Memo : _____

- The settings in [Video]-[First Stream] will be applied as the video settings.

↳ Second Stream

For configuring the RTMP(S) Second Stream video. Configure the setting to “on” for streaming and press the [Submit & Reboot] button. RTMP(S) streaming will start after the camera is restarted. [Setting values: on, off]

Memo : _____

- The settings in [Video]-[Second Stream] will be applied as the video settings.

↳ MRL

For configuring the streaming server address for the RTMP(S) First Stream/Second Stream. First Stream [Default Value: rtmp://192.0.2.1/live/stream0] Second Stream [Default Value: rtmp://192.0.2.2/live/stream1]

MPEG2-TS Setting

For configuring the MPEG2-TS setting.

[Setting Values: ●RTP, UDP]

↳ First Stream/Second Stream

For configuring the First Stream/Second Stream of MPEG2-TS.

[Setting Values: on, ●off]

↳ Destination Address

For configuring the IP address of the destination.

[Setting values: 192.0.2.1 (First stream), 192.0.2.2 (Second stream)]

↳ Port

For setting the port of the live streaming destination.

The default values are “6688” (First stream) and “6690” (Second stream).

ZeroConfig

For allowing this camera to be detected automatically by external devices (such as switchers) connected to the same LAN. Connection can be established via one link from the menu of the external device.

Memo : _____

- The Zero Config function is not equipped with the function to change the settings of the camera.

↳ Announcement

For configuring the method of connection from an external device during automatic detection of this camera.

[Setting Values: ●on, off]

↳ Hostname Prefix

Part of the host name can be changed. (Up to 8 characters)

The default value is “PZ510”.

Memo : _____

The following setting values are common. Any changes made to an item will cause the other items to be changed at the same time.

- [Network] → [ZeroConfig] → [Hostname Prefix]
- [NDI Settings] → [NDI Settings] → [NDI Local Device Name] **510N**
- [Information] → [Information] → [Device ID]

NTP Settings

Enables display of time information acquired from the NTP server on the streaming video.

↳ NTP time sync

Configuring to “on” enables time information to be acquired from the NTP server.

[Setting Values: on, ●off]

↳ Time Zone

For setting the GMT time difference in units of 1 hour.

[Setting Values: GMT-11:00 to GMT +13:00(●GMT-05:00 (U model)), (●GMT+00:00 (E model))]

↳ Server address

For setting the address of the NTP server.

[Default Value: ntp.example.com]

↳ Time interval(min)

For configuring the interval between time queries to the NTP server to a value between 0 and 99999.

[Default Value: 1440]

↳ Main time show, Sub time show

Configuring to “on” displays the NTP time information on the streaming video.

[Setting Values: on, ●off]

Memo : _____

- To display the NTP time information on the live screen, configure [Encode Codec] of [First Stream] or [Second Stream] to “H.264”. If the display is too small, decrease the [Resolution] for [First Stream] or [Second Stream] accordingly.

↳ Position

For configuring the position for displaying the First Stream time or Second Stream time.

Configure the display position with the top left corner of the screen as [X0, Y0] and the bottom right corner as [X100, Y100].

[Default Values: X0, Y0]

Port Settings

↳ HTTP Port

For configuring the HTTP port.
[Setting Values: ●80 or 1025 to 65535]

↳ UDP Port

For configuring the UDP port.
[Setting Values: 1025 to 65535 (●1259)]

↳ Standard Protocol

Displays the Standard Protocol port number.

Memo : _____

- Not changeable.

Lan Settings

↳ IP Configuration Type

For selecting the method for configuring the IP address.
[Setting Values: Dynamic IP Address, ●Fixed IP Address]

↳ IP Address

Displays the current IP address.
The IP address of the camera can be configured manually when [IP Configuration Type] is configured to "Fixed IP Address".
The default value is 192.168.0.10.

↳ Subnet Mask

Displays the address of the current subnet mask.
The subnet mask of the camera can be configured manually when [IP Configuration Type] is configured to "Fixed IP Address".

↳ Gateway

Displays the address of the current default gateway.
The default gateway of the camera can be configured manually when [IP Configuration Type] is configured to "Fixed IP Address".

↳ DNS Address

Displays the current DNS address.
The DNS address of the camera can be configured manually when [IP Configuration Type] is configured to "Fixed IP Address".

↳ MAC Address

Displays the MAC address of the camera.

Memo : _____

- Not changeable.

NDI Config **510N**

This is the setting screen for the NDI (Network Device Interface) protocol.
After configuring the items, press the [Submit & Reboot] or [Submit] button.
The settings will be applied when the camera is next restarted.

NDI Settings

↳ NDI Local Device Name

For configuring the device name displayed in the NDI application.
[Default Value: PZ510]

Memo : _____

The following setting values are common. Any changes made to an item will cause the other items to be changed at the same time.

- [Network] → [ZeroConfig] → [Hostname Prefix]
- [NDI Settings] → [NDI Settings] → [NDI Local Device Name] **510N**
- [Information] → [Information] → [Device ID]

↳ NDI Receive Group

For configuring the group name to be used for the NDI application.
The default value is "public".

↳ NDI Firmware Version

Displays the NDI firmware version.

Information

Information

↳ Device ID

For configuring the device name of this unit.
The default value is “PZ510”.

Memo : _____

The following setting values are common. Any changes made to an item will cause the other items to be changed at the same time.

- [Network] → [ZeroConfig] → [Hostname Prefix]
- [NDI Settings] → [NDI Settings] → [NDI Local Device Name] **510N**
- [Information] → [Information] → [Device ID]

↳ Device Type

Displays the device type of this unit.

↳ Software Version

Displays the current software version.

↳ Webware Version

Displays the current web-based software version.

↳ Open Source License

Displays the license for the open source software used by this camera.

Network Status

Displays the current streaming setting values.

Basic Shooting Procedures

Preparations

- 1 **Supply power to the camera via a LAN cable or AC adapter.**
(☞ P24 [Connecting the Cables])
- 2 **Turn on the power switch.**
- 3 **Configure the IP address of the camera.**
For viewing the IP address of the camera and configuring the IP address.
(☞ P25 [Checking the IP address])
(☞ P25 [IP address settings])
- 4 **Check the connection.**
(☞ P26 [Confirming the Connection])

Memo : _____

- You are recommended to operate this camera by connecting it to a PC or a controller. The supplied infrared remote control unit might not work depending on the conditions of installation.

Selecting the Video Output Resolution and Frame Rate

This camera allows you to select the video format for the output video.

Setting a Video Format

- 1 **Set [Video]→[Video Settings]→[Video Format].**
- 2 **After setting is complete, press the [Submit & Reboot] button.**
 - When [Video]→[Video Settings]→[HDMI/SDI Output] is set to "HDMI"
3840X2160/60p, 3840x2160/59.94p, 3840x2160/50p, 3840x2160/30p, 3840x2160/29.97p, 3840x2160/25p, 1920x1080/60p, 1920x1080/59.94p, 1920x1080/50p, 1920x1080/60i, 1920x1080/59.94i, 1920x1080/50i, 1920x1080/30p, 1920x1080/29.97p, 1920x1080/25p, 1280x720/60p, 1280x720/59.94p, 1280x720/50p
 - When [Video]→[Video Settings]→[HDMI/SDI Output] is set to "SDI"
1920X1080/60p, 1920x1080/59.94p, 1920x1080/50p, 1920x1080/60i, 1920x1080/59.94i, 1920x1080/50i, 1920x1080/30p, 1920x1080/29.97p, 1920x1080/25p, 1280x720/60p, 1280x720/59.94p, 1280x720/50p

Performing Live Streaming

By combining with the decoder or PC application that supports live streaming, you can perform audio and video streaming via the network.

Supported Codecs

H.264, H.265, Motion JPEG

Supported Formats

[Streaming resolution (First Stream)]

3840x2160, 1920x1080, 1280x720, 1024x576, 720x480, 720x408, 640x480, 640x360

[Streaming resolution (Second Stream)]

720x480, 720x408, 640x480, 640x360, 480x320, 320x240

[Frame rate (for streaming resolution of 3840x2160)]

30p, 29.97p, 25p

[Frame rate (when streaming resolution is other than 3840x2160)]

60p, 59.94p, 50p, 30p, 29.97p, 25p

[Audio]

AAC, 48kHz, 96kbps/128kbps

Memo : _____

- The range of configurable resolutions and bitrates varies according to the codec that has been selected.
- Depending on the connection environment, images and audio sound during live streaming may be choppy.

Supported Protocols

RTSP/RTP, RTMP/RTMPS, SRT, MPEG2-TS/RTP, MPEG2-TS/UDP, NDI|HX **510N**

Setting Distribution

1 Configure the streaming video and audio format.

Configure the codec, resolution, frame rate and bitrate settings in [Video] and [Audio] of the View Remote.

2 Set the distribution protocol.

Configure the streaming protocol and related items in the [Network] settings of the View Remote.

3 Restart the camera.

After configuring the different items, press the [Submit & Reboot] button to restart the camera. Alternatively, press the [Submit] button followed by pressing the [Reboot] button in the [System] menu to restart the camera.

Receive streaming data

Streaming starts automatically after the camera has restarted. Configure the necessary settings for the decoder and PC application to receive streaming data.

■ URL when receiving streaming data using RTSP/RTP

• First Stream

rtsp://<IP address of this unit>:<Port no.>/1

• Second Stream

rtsp://<IP address of this unit>:<Port no.>/2

(Example) rtsp://192.168.0.10:554/1

■ When receiving streaming data using RTMP(S)
Enter the server and stream key into the MRL field under the RTMP(S) setting in the [Network] settings of the View Remote, and view the content from the designated video link after restarting the camera.

■ URL when receiving streaming data using SRT

srt://<IP address of this unit>:<Port no.>?

mode=<SRT mode>

(Example) srt://192.168.0.10:4578?mode=caller

■ URL when receiving streaming data using MPEG2-TS

rtp://@:<Port no.>

(Example) rtp://@:6688

rtp://<IP address for MPEG2-TS>:<Port no.>

(Example) rtp://192.0.2.1:6688

udp://@:<Port no.>

(Example) udp://@:6688

udp://<IP address for MPEG2-TS>:<Port no.>

(Example) udp://192.0.2.1:6688

■ When receiving streaming data using

NDI|HX **510N**

Install the NDI Tools on the PC for viewing. For more information, please refer to the instruction manual of the NDI Tools.

Supported Streaming Formats

You can configure the detailed settings for streaming by setting [Video]→[Setup Type] to “manual”. Streaming formats that are supported using the [Video]→[Video Settings]→[Video Format] setting are as follows.

Configure [Video Format] according to the format to be used for streaming.

Video Format	Stream	Resolution									
		3840x2160	1920x1080	1280x720	1024x576	720x480	720x408	640x480	640x360	480x320	320x240
3840x2160/60p 3840x2160/59.94p 3840x2160/50p	First	—	✓	✓	✓	✓	✓	✓	✓	—	—
	Second	—	—	—	—	✓	✓	✓	✓	✓	✓
3840x2160/30p 3840x2160/29.97p 3840x2160/25p	First	✓*1	✓	✓	✓	✓	✓	✓	✓	—	—
	Second	—	—	—	—	✓	✓	✓	✓	✓	✓
1920x1080/**p 1920x1080/**l 1280x720/**p	First	✓	✓	✓	✓	✓	✓	✓	✓	—	—
	Second	—	—	—	—	✓	✓	✓	✓	✓	✓

*1 When [Video Format] is set to “3840x2160/**p”, the configurable frame rate is up to 30p when the [Resolution] for streaming is 3840x2160.

Memo :

- MJPEG does not support streaming at 3840x2160.

Menu Screen Hierarchical Chart

Menu	(P 43)	P/T/Z	(P 46)
EXPOSURE	(P 43)	SpeedByZoom	(P 46)
Mode	(P 43)	AF-Zone	(P 46)
ExpCompMode	(P 43)	AF-Sense	(P 46)
ExpComp	(P 43)	L/R Set	(P 46)
Backlight	(P 43)	Display Info	(P 46)
Bright	(P 44)	Image Freeze	(P 46)
Iris	(P 44)	Digital Zoom	(P 46)
Shutter	(P 44)	Call Preset Speed	(P 46)
Gain	(P 44)	Pre Zoom Speed	(P 46)
Gain Limit	(P 44)	SETUP	(P 47)
Anti-Flicker	(P 44)	Language	(P 47)
Meter	(P 44)	Auto Inversion	(P 47)
DRC	(P 44)	Tally Mode	(P 47)
COLOR	(P 45)	LCD Info.	(P 47)
WB Mode	(P 45)	COMMUNICATION SETUP	(P 47)
R Gain	(P 45)	Protocol	(P 47)
RG Tuning	(P 45)	V_Address	(P 47)
B Gain	(P 45)	V_AddrFix	(P 47)
BG Tuning	(P 45)	Net Mode	(P 47)
Saturation	(P 45)	P_D_Address	(P 47)
Hue	(P 45)	P_P_Address	(P 47)
Image	(P 46)	Baudrate	(P 47)
Luminance	(P 46)	Video Settings	(P 48)
Contrast	(P 46)	Output	(P 48)
Sharpness	(P 46)	Format	(P 48)
Flip-H	(P 46)	HDMI Mode	(P 48)
Flip-V	(P 46)	DVI Mode	(P 48)
B&W Mode	(P 46)	SDI-3G Mode	(P 48)
Style	(P 46)	Restore Default	(P 49)
NR3D-Level	(P 46)	Restore?	(P 49)
		P/T Limit Reset	(P 49)

Memo :

- Some menus cannot be set depending on the operating mode or status of the camera. These items are displayed in gray, and they cannot be selected.
- Setting value with the ● mark is the factory default.

GUI Settings

Menu

Pressing the [MENU] button on the infrared remote control unit displays the main menu on the HDMI/SDI and streaming screens. You can move the cursor using the arrow buttons. Use the [HOME] button to enter the corresponding menu.



Memo : _____

- To display the menu on the video image on the View Remote screen, configure [Encode Codec] of [First Stream] or [Second Stream] to "H.264". If the menu display is too small, decrease the [Resolution] for [First Stream] or [Second Stream] accordingly.

Exposure

Mode

For selecting the method for controlling the exposure.

- Auto
Gain/Shutter/Iris are adjusted automatically.
- Manual
Gain/Shutter/Iris operate according to the menu setting.
- SAE
Shutter speed is configured according to the setting in the [Shutter] menu, while gain and iris is automatically adjusted.
- AAE
Iris is configured according to the setting in the [Iris], while gain and shutter speed are automatically adjusted.
- Bright
Adjusts the brightness of the RAW data.

[Setting Values: ●Auto, Manual, SAE, AAE, Bright]

ExpCompMode

Performs exposure compensation when this is configured to "On".

[Setting Values: ●Off, On]

Memo : _____

- This item can be configured when [Mode] is set to "Auto".

↳ ExpComp

Adjusts the exposure compensation value.

[Setting Values: -7 to +7 (●0)]

Memo : _____

- This item can be configured when [ExpCompMode] is set to "On".

Backlight

For configuring backlight compensation.

[Setting Values: ●Off, On]

Memo : _____

- This item can be configured when [Mode] is set to "Auto".

Bright

Adjusts the brightness.

[Setting Values: 0 to 17 (●7)]

Memo : _____

- This item can be configured when [Mode] is set to "Bright".

Iris

For configuring the iris value (F number).

[Setting Values: ●F1.8, F2.0, F2.4, F2.8, F3.4, F4.0, F4.8, F5.6, F6.8, F8.0, F9.6, F11.0, Close]

Memo : _____

- This item can be configured when [Mode] is configured to "Manual" or "AAE".

Shutter

For configuring the shutter speed.

- For "60Hz"[Video Format]
[Setting Values: 1/30, ●1/60, 1/90, 1/100, 1/125, 1/180, 1/250, 1/350, 1/500, 1/725, 1/1000, 1/1500, 1/2000, 1/3000, 1/4000, 1/6000, 1/10000]
- For "50Hz"[Video Format]
[Setting Values: 1/25, ●1/50, 1/75, 1/100, 1/120, 1/150, 1/250, 1/350, 1/500, 1/725, 1/1000, 1/1500, 1/2000, 1/3000, 1/4000, 1/6000, 1/10000]

Memo : _____

- This item can be configured when [Mode] is configured to "Manual" or "SAE".
- "1/30" can be selected when frame rate is configured to 30p/29.97p, and "1/25" can be selected when frame rate is configured to 25p. (P39 [Selecting the Video Output Resolution and Frame Rate])

Gain

This function electrically boosts the light sensitivity when there is insufficient illumination on the object. You can set the gain of the video amplifier according to the brightness of the object.

[Setting Values: ●0dB, 3dB, 6dB, 9dB, 12dB, 15dB, 18dB, 21dB, 24dB, 27dB, 30dB, 33dB, 36dB, 39dB, 42dB, 45dB]

Memo : _____

- This item can be configured when [Mode] is set to "Manual".

Gain Limit

For setting the maximum value of the operation that automatically switches to the electrically boosted sensitivity level according to the brightness.

[Setting Values: 3dB, 6dB, 9dB, 12dB, 15dB, 18dB, 21dB, 24dB, ●27dB, 30dB, 33dB, 36dB, 39dB, 42dB, 45dB]

Memo : _____

- This item can be configured when [Mode] is configured to "Auto", "SAE", "AAE" or "Bright".

Anti-Flicker

For correcting video image flicker that occurs under a fluorescent light.

[Setting Values: 50Hz, ●60Hz, Off] (U model)

[Setting Values: ●50Hz, 60Hz, Off] (E model)

Memo : _____

- This item can be configured when [Exposure] is configured to "Auto", "AAE" or "Bright".

Meter

Shutter speed, iris (F number) and ISO speed are controlled to adjust the exposure to an appropriate level according to the brightness of the subject in the [Mode] settings. Use this setting to configure the method of compensation in this case.

[Setting Values: ●Average, Center, Smart, Top]

Memo : _____

- This item can be configured when [Mode] is configured to "Auto", "SAE", "AAE" or "Bright".

DRC

Adjusts the intensity of DRC.

[Setting Values: 0 to 8 (●0)]

Color

WB Mode

For setting the white balance mode.

- Auto
Automatically adjusts the white balance according to the color temperature of the lighting for illuminating the subject.
- Indoor
For configuring to a color temperature that is suitable for indoor shooting.
- Outdoor
For configuring to a color temperature that is suitable for outdoor shooting.
- OnePush
When “OnePush” is selected, pressing the [HOME] button adjusts the white balance according to the color temperature of the lighting that is currently used to illuminate the subject.
- Manual
Enables adjustment of the color temperature using R gain and B gain.

[Setting Values: ●Auto, Indoor, Outdoor, OnePush, Manual]

R Gain

Adjusts the R (red) gain in the Manual mode.

[Setting Values: 0 to 255 (●61)]

Memo : _____

- This item can be configured when [WB Mode] is set to “Manual”.

RG Tuning

Fine-tunes the R (red) component.

[Setting Values: -10 to +10 (●0)]

Memo : _____

- This item can be configured when [WB Mode] is set to “Auto”.

B Gain

Adjusts the B (blue) gain in the Manual mode.

[Setting Values: 0 to 255 (●67)]

Memo : _____

- This item can be configured when [WB Mode] is set to “Manual”.

BG Tuning

Fine-tunes the B (blue) component.

[Setting Values: -10 to +10 (●0)]

Memo : _____

- This item can be configured when [WB Mode] is set to “Auto”.

Saturation

Adjusts the color density.

[Setting Values: 60% to 200% (●100%)]

Hue

For setting the color phase.

[Setting Values: 0 to 14 (●7)]

Image

Luminance

For adjusting the brightness.

[Setting Values: 0 to 14 (●7)]

* When [Style] is set to a value other than “Bright”

[Setting Values: 0 to 14 (●8)]

* When [Style] is set to “Bright”

Contrast

For adjusting the contrast.

[Setting Values: 0 to 14 (●7)]

* When [Style] is configured to “Default” or “Norm”

[Setting Values: 0 to 14 (●9)]

* When the [Style] item is configured to “Bright” or “PC”

Sharpness

Adjusts the outline correction value.

[Setting Values: 0 to 11 (●6)]

* When [Style] is configured to “Default” or “Norm”

[Setting Values: 0 to 11 (●7)]

* When the [Style] item is configured to “Bright” or “PC”

Flip-H

Flips the video image in the horizontal direction.

[Setting Values: ●Off, On]

Flip-V

Flips the video image in the vertical direction.

[Setting Values: ●Off, On]

B&W Mode

Switches the video to a grayscale display.

[Setting Values: ●Off, On]

Style

For configuring the picture quality adjustment mode.

[Setting Values: ●Default, Norm, Bright, PC]

Memo : _____

- The settings will not be reset even when you press the RESTORE switch.

NR3D-Level

For configuring 3D noise reduction.

[Setting Values: Auto, Off, 1 to 8 (●6)]

P/T/Z (P/T/Z)

SpeedByZoom

Configuring to “On” reduces the speed of pan/tilt movement further as the camera zooms toward the Tele-end.

[Setting Values: ●On, Off]

AF-Zone

For configuring the auto focus reference area.

[Setting Values: ●Center, Bottom, Front, Top]

AF-Sense

Adjusts the auto focus sensitivity level.

[Setting values: ●High, Low, Normal]

L/R Set

Inverts the pan operation.

STD : Use the Right cursor button to move to the right, and the Left button to move to the left

REV : Use the Right cursor button to move to the left, and the Left button to move to the right

[Setting Values: ●STD, REV]

Display Info

Configuring to “On” shows a “Registration is complete” OSD when you have registered a preset position.

[Setting Values: ●On, Off]

Image Freeze

Setting to “On” displays the video image before movement starts as a still image during the interval after preset starts until the camera has reached the registered position.

[Setting Values: ●Off, On]

Digital Zoom

For configuring the digital zoom factor.

[Setting Values: ●Off, 2x, 4x, 8x, 16x]

Call Preset Speed

For configuring the preset pan/tilt speed.

[Setting Values: 1 to 24 (●20)]

Pre Zoom Speed

For configuring the preset zoom speed.

[Setting Values: 0 to 7 (●5)]

Setup

Language

Switches between languages in the menu screen.
[Setting values: ●EN, Français, Deutsch, In Italia, Español, русский, 中文, 日本語]

Auto Inversion

For configuring the auto flip setting of the video output.

On : Flips the video image when the camera is mounted to the ceiling. Video is not flipped when the camera is installed on a desktop.

Off : Does not flip the video image when the camera is mounted to the ceiling.

[Setting Values: ●On, Off]

Tally Mode

For configuring whether to light up the tally lamp at the front of the camera.

[Setting Values: ●On, Off]

LCD Info.

For configuring the LCD Info..

[Setting Values: ●On, Off]

Communication Setup

Protocol

For configuring the control protocols.

[Setting Values: ●Standard, PELCO-D, PELCO-P, Auto]

V_Address

For configuring the address of the Standard protocol.

[Setting Values: 1 to 7 (●1)]

Memo : _____

- This item can be configured when [Protocol] is configured to "Standard" or "Auto".

V_AddrFix

For configuring the necessity of the Address Set command.

On : Address Set command is not needed.

Off : Address Set command is needed.

[Setting Values: ●Off, On]

Memo : _____

- This item can be configured when [Protocol] is configured to "Standard" or "Auto".

Net Mode

For configuring the serial port network control.

[Setting Values: ●Serial, Paral]

Memo : _____

- This item can be configured when [Protocol] is configured to "Standard" or "Auto".

P_D_Address

For configuring the address of PELCO-D.

[Setting Values: 0 to 254 (●1)]

Memo : _____

- This item can be configured when [Protocol] is configured to "PELCO-D" or "Auto".

P_P_Address

For configuring the address of PELCO-P.

[Setting Values: 0 to 31 (●0)]

Memo : _____

- This item can be configured when [Protocol] is configured to "PELCO-P" or "Auto".

Baudrate

For configuring the baud rate of the serial port.

[Setting Values: 2400, 4800, ●9600, 38400]

Video Settings

Output

For setting the terminal to output the video.
[Setting Values: ●HDMI, SDI]

Memo : _____

- Press the [HOME] button to confirm and restart the camera. Changes to the setting values are reflected by restarting each item. If you move to another item without restarting, the setting value will be restored when you exit the menu.

Format

For setting a video format for the HDMI or 3G-SDI output.

- When the video output is "HDMI"
[Setting Values: 3840x2160/60p,
3840x2160/59.94p,3840x2160/50p,
3840x2160/30p,3840x2160/29.97p,
3840x2160/25p,1920x1080/60p,
1920x1080/60i,1920x1080/59.94p,
1920x1080/59.94i,1920x1080/50p,
1920x1080/50i,1920x1080/30p,
1920x1080/29.97p,1920x1080/25p,
1280x720/60p,1280x720/59.94p,
1280x720/50p]

Memo : _____

- When DVI Mode is set to "DVI", 3840x2160/60p, 3840x2160/59.94p, 3840x2160/50p cannot be configured.
- When the video output is "SDI"
[Setting Values: 1920x1080/60p,
1920x1080/60i,1920x1080/59.94p,
1920x1080/59.94i,1920x1080/50p,
1920x1080/50i,1920x1080/30p,
1920x1080/29.97p,1920x1080/25p,
1280x720/60p,1280x720/59.94p,
1280x720/50p]

[Default Value: 1920x1080/59.94p] (U model)

[Default Value: 1920x1080/50p] (E model)

Memo : _____

- Press the [HOME] button to confirm and restart the camera. Changes to the setting values are reflected by restarting each item. If you move to another item without restarting, the setting value will be restored when you exit the menu.

HDMI Mode

For setting the color format of HDMI signals.
[Setting Values: ●YUV, RGB]

Memo : _____

- Press the [HOME] button to confirm and restart the camera. Changes to the setting values are reflected by restarting each item. If you move to another item without restarting, the setting value will be restored when you exit the menu.

DVI Mode

For configuring the audio output from the HDMI terminal.

HDMI : Outputs the audio.

DVI : Mutes the audio.

[Setting Values: ●HDMI, DVI]

Memo : _____

- Press the [HOME] button to confirm and restart the camera. Changes to the setting values are reflected by restarting each item. If you move to another item without restarting, the setting value will be restored when you exit the menu.

SDI-3G Mode

For setting the 3G-SDI mapping structure.
[Setting Value: ●LEVEL-A,LEVEL-B]

Restore Default

Restore?

Resets all the menu item settings except for the language setting.

[Setting Values: ●No, Yes]

Memo : _____

- Press the [HOME] button to confirm the selection.
Preset values will also be initialized.
IP address, web password and View Remote settings will not be initialized.

P/T Limit Reset

Resets only the menu settings.

[Setting Values: ●No, Yes]

Memo : _____

- Press the [HOME] button to confirm the selection.

Auto-Tracking

The Auto-tracking function enables the camera to automatically pan, tilt, and zoom so that the specified person is always displayed in the center of the screen.

| Only One Person in the Camera Image

1 Press the F3 button on the remote control to start tracking.

Adjust the angle and zoom so that the person you want to track is in the center of the camera image.

If there is only one person in the camera image, press the F3 button on the remote control to lock the target and start tracking.

When the tracking target cannot be detected, the camera will stop at that position and automatically resume tracking when the tracking target appears again.

Memo : _____

- During Auto-Tracking, the Auto-Tracking function may not work depending on the conditions of surrounding and people.
- During Auto-Tracking, the following operations are not allowed.
Pan, tilt, zoom, moving to the Preset, manual focus and displaying the menu

2 Press the F4 button on the remote control to stop tracking.

| Multiple People in the Camera Image

1 Press the F3 button on the remote control and select the target using the left and right buttons.

If there are multiple people in the camera image when the F3 button on the remote control is pressed, a green frame for selecting the tracking target is displayed.

Use the left and right buttons on the remote control to move the cursor to the person to be tracked.

Detection Frame (Green)

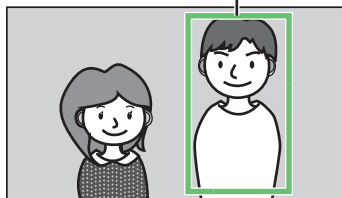

2 Press the [HOME] button on the remote control to start tracking.

Pressing the [HOME] button on the remote control hides the frame and starts the tracking. To change the target to be tracked, do so using the left and right buttons on the remote control. When the tracking target cannot be detected, the camera will stop at that position and automatically resume tracking when the tracking target appears again.

Memo : _____

- During Auto-Tracking, the Auto-Tracking function may not work depending on the conditions of surrounding and people.
- During Auto-Tracking, the following operations are not allowed.
Pan, tilt, zoom, moving to the Preset, manual focus and displaying the menu

3 Press the F4 button on the remote control to stop tracking.

Configuring Setup Files

This camera allows you to save the menu settings as a setup file on a PC. Loading a saved setup file enables you to reproduce the appropriate setup state speedily. Use the firmware update application (upgrade_standard.exe) to save (export) and load (import) the setup file.

- 1 Connect the camera to a PC on the same network and run "upgrade_standard.exe" on the PC.
- 2 Click the [Search] button.
Cameras connected on the same network are displayed.

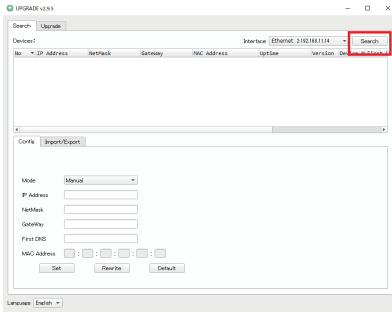

- 3 Select the camera to save the setup file.

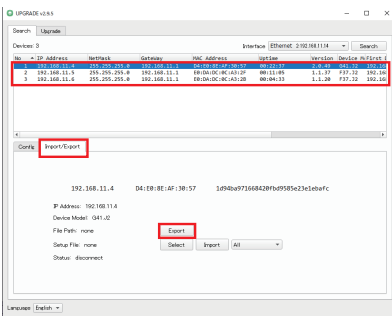

- 4 Click the [Import/Export] tab.

The information of the selected camera is displayed.

To save the setup file:

[Saving the Setup File (Export)] (P 51)

To load the setup file:

[Loading the Setup Files (Import)] (P 52)

Saving the Setup File (Export)

- 5 Click the [Export] button.

A dialog box to save the file is displayed.

Specify the destination to save and a file name.

- 6 Click the [Save] button.

The setup file is saved to the specified folder.

An "Export Success" message appears if the saving is successful.

Memo :

The settings for saving are as follows.

- Preset positions (255 positions)
- Setting values
However, the following setting values are not saved in the setup file.
 - [Video] of the View Remote screen
 - [System]→[User] settings of View Remote
 - [Network]→[Lan Settings] settings of View Remote

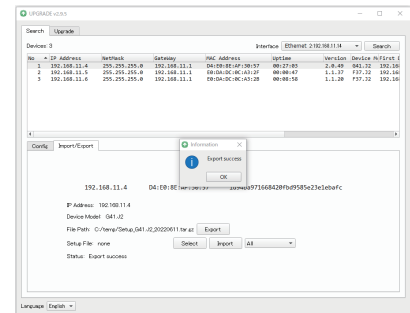
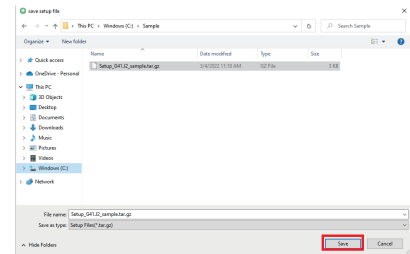

Troubleshooting

Problem	Action
Video image does not appear on the monitor	<ul style="list-style-type: none"> ● Check to ensure that the power supply of the camera is properly connected, the power voltage is normal and the POWER lamp is on at all times. ● Check that the monitor is turned on, restart the camera and check if the initialization is performed. ● Check the video format setting and whether the monitor cable is properly connected.
Sometimes the video image is not displayed	Check the video format setting and whether the monitor cable is properly connected.
Video image becomes blurry when zoomed to the Tele end	<ul style="list-style-type: none"> ● Check whether the camera is installed at a stable location. ● Check to ensure that there are no vibrating machines or objects near the camera.
Video image does not appear on the Web browser	You can use the VLC media player to receive video and audio streams. Access the VLC website. (http://www.videolan.org/vlc) Download and install the VLC media player.
Unable to access camera from the Web browser	<ol style="list-style-type: none"> ① Access the network using a PC to test whether network access is functioning properly. ② Disconnect from the network, connect the camera and the PC separately, and reset the IP address of the PC. ③ Check the IP address, subnet mask and gateway settings of the camera. ④ Check to ensure that there is no conflict in the MAC address. ⑤ Check whether the HTTP port is occupied by a different device.
I forgot the IP address or login password	Manage the password properly to avoid forgetting it. If you forgot the password, reset the camera to return to its default settings. (Default IP address: 192.168.0.10; default user name: jvc; default password: 0000)
Unable to control using the remote control unit	<ul style="list-style-type: none"> ● Replace the batteries in the remote control with new ones and check again. ● Check whether the camera is in the correct operation mode. ● Check whether the camera number configured using the remote control unit matches the number of the camera.
Unable to control via the serial port	<ul style="list-style-type: none"> ● Check to ensure that the protocol and address of the camera are consistent. ● Check whether the cables are properly connected.
Video and audio distortion during streaming	<ul style="list-style-type: none"> ● If the [Encode Codec] is configured to “H.264” or “H.265”, changing the [Bit Rate] may improve the condition. ● If [Encode Codec] is configured to “MJPEG”, changing the [Qfactor] may improve the condition.

Specifications

General

Item	Description
Power	DC 12 V (when an AC adapter is used) PoE+
Current consumption	0.95 A (*1) 0.25 A (*2)
Mass	Approx. 2.0 kg
Allowable operating temperature	0 °C to 40 °C (32 °F to 104 °F)
Allowable operating humidity	30 %RH to 80 %RH (No condensation)
Allowable storage temperature	-20 °C to 50 °C (-4 °F to 122 °F)
Dimensions (W × H × D) (*3)	223.0 mm x 166.4 mm x 163.0 mm
MTBF	> 30000 h

*1 Operated in the factory default settings when an AC adapter is in use.

*2 Operated in the factory default settings when using power supply from a PoE+ via a LAN cable.

*3 When the tilt position is horizontal.

Terminal Section

Item	Description
[LINE IN] terminal	Φ3.5 mm Line input
[RS485] terminal	2-pin Phoenix port Protocols: Standard/Pelco-D/ Pelco-P
[RS232 IN] terminal	8-pin mini DIN Protocols: Standard/Pelco-D/ Pelco-P
[RS232 OUT] terminal	8-pin mini DIN Protocol: Use only Standard network
[LAN] terminal	RJ-45 PoE+ power supply: DC 42.5 V to 57 V Ethernet: 10BASE-T/ 100BASE-TX/1000BASE-T

Item	Description
[3G-SDI] terminal	BNC type 720p/1080i/1080p: embedded audio 3G-SDI: SMPTE ST424- compliant HD-SDI: SMPTE ST292- compliant
[HDMI] output terminal	Type A
[USB 2.0] terminal	USB Type-C
[DC 12V] terminal	For use with the supplied AC adapter

Lens/Camera

Item	Description
Lens	12x, f=3.4 mm to 41.6 mm, F1.8 to F3.7
Image pickup device	1/2.8-inch Progressive CMOS, maximum effective pixel: 8.4 Megapixels
Digital Zoom	16x
Shutter	1/25 s to 1/10000 s
White balance	Auto, Indoor, Outdoor, One Push, Manual
Backlight compensation	Available
Digital noise reduction	3D digital noise reduction
H&V flip	Available
Image Freeze	Available
No. of presets	255
Presets accuracy	0.1°

Rotation Mechanism Section

Item	Description
Horizontal viewing angle	80.0° to 8.0°
Vertical viewing angle	50.5° to 4.5°
Horizontal rotation range	±162.5°
Vertical rotation range	-30° to +90°
Horizontal rotation speed	1.8°/sec to 80.5°/sec
Vertical rotation speed	1.5°/sec to 49°/sec

Video

Item	Description
Signal system	3840x2160/60p, 50p, 30p, 25p, 59.94p, 29.97p 1920x1080/60p, 50p, 30p, 25p, 59.94p, 29.97p, 60i, 50i, 59.94i 1280x720/60p, 50p, 59.94p

Network

Item	Description
Video compression	H.264, H.265, Motion JPEG
Video stream	First Stream Second Stream
First Stream resolution	3840x2160, 1920x1080, 1280x720, 1024x576, 720x480, 720x408, 640x480, 640x360
Second Stream resolution	720x480, 720x408, 640x480, 640x360, 480x320, 320x240
Video bit rate	32 kbps to 61440 kbps
Bit rate type	CBR, VBR
Frame rate	60fps, 59.94fps, 50fps, 30fps, 29.97fps, 25fps
Audio compression	AAC
Audio bit rate	96 kbps, 128 kbps
Protocols	Control: Standard, NDI HX 510N Streaming: RTSP/RTP, RTMP/RTMPS, SRT, MPEG2-TS/RTP, MPEG2-TS/UDP, NDI HX 510N

Infrared Remote Control

Item	Description
Remote control system	Infrared type
Battery	AAA dry-cell battery x 2
Battery life	Approx. 1 year (varies with the frequency of use)
Operating distance	8 m (horizontal distance from the front)
Allowable operating temperature	0 °C to 40 °C (32 °F to 104 °F)
Dimensions (W x H x D)	46 mm x 20.8 mm x 168.1 mm
Mass	Approx. 90 g

Accessories

Accessories	
Warranty Card (U model only)	1
保修卡 (E model only / For China)	1
INSTRUCTIONS (Installation/IP Address Settings)	1
使用说明书(安装/IP 地址设置) (E model only / For China)	1
AC Adapter	1
Power Cord (U model: 1, E model: 2)	
RS232C cable	1
Remote control unit	1
Ceiling mount bracket set	1
Screws (M3)	7
JVC logo label	2
Lens cap	1

* The warranty card can be found inside INSTRUCTIONS (Installation/IP Address Settings).

Dimensional Outline Drawing (Unit: mm)

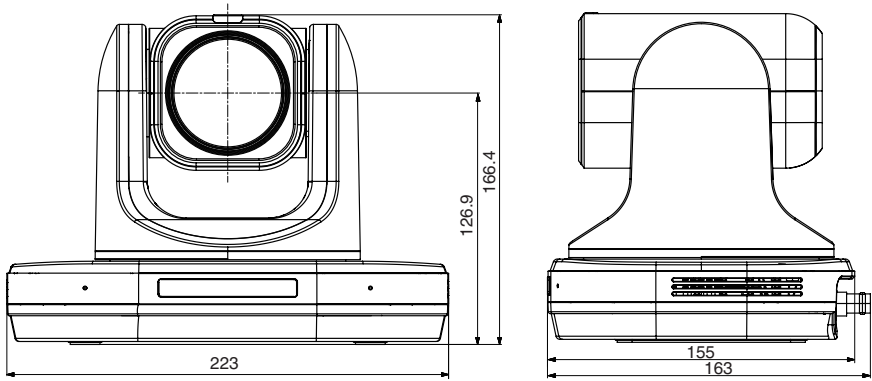

* The specifications and appearance of this product are subject to changes for further improvement without prior notice.

Software License Agreement

The software embedded in the Product (hereinafter the “Licensed Software”) provided by JVCKENWOOD Corporation (hereinafter the “Licensor”) is copyrighted to or sublicenseable by the Licensor, and this Agreement provides for the terms and conditions which Users shall follow in order to use the Licensed Software. The User shall use the Licensed Software by agreeing with the terms of this Software License Agreement. This Agreement shall be deemed completed at the time the User (hereinafter the “User”) initially used the Product in which the “Licensed Software” is embedded. The Licensed Software may include the software which has been licensed to the Licensor directly or indirectly from any third party. In such case, some third parties require the Users to follow their conditions for use separately from this Software License Agreement. Such software shall not be subject to this Agreement, and the Users are urged to read the “Important Notice concerning the Software” to be provided separately.

Article 1 General Provision

The Licensor shall grant to the User a non-exclusive and non-transferable (other than the exceptional case referred to in Article 3, Paragraph 1) licensed to use the Licensed Software within the country of the User (the country where the User bought the Product (hereinafter the “Country”).

Article 2 License

1. The license granted under this Agreement shall be the right to use the Licensed Software in the Product.
2. The User shall not duplicate, copy, modify, add, translate or otherwise alter, or lease the Licensed Software and any related documents, whether in whole or in part.
3. The use of the Licensed Software shall be limited to personal purpose, and the Licensed Software shall not be distributed, licensed or sub-licensed whether it is for commercial purpose or not.
4. The User shall use the Licensed Software according to the directions described in the operation manual or help file, and is prohibited to use or duplicate any data in a manner violating the Copyright Law or any other laws and regulations by applying whole or a part of the Licensed Software.

Article 3 Conditions for Grant of License

1. When the User transfers the Product, it may also transfer the license to use the Licensed Software embedded in the Product (including any related materials, updates and upgrades) on condition that no original, copies or related materials continue in the possession of the User, and that the User shall cause the transferee to comply with this Software License Agreement.
2. The User shall not carry out reverse engineering, disassembling, decompiling or any other code analysis works in connection with the Licensed Software.

Article 4 Right pertaining to the Licensed Software

1. Any and all copyrights and other rights pertaining to the Licensed Software and related documents shall belong to the Licensor or the original holder of the right who granted to the Licensor the license or sublicense for the Licensed Software (hereinafter the “Original Rightholder”), and the User shall not be entitled to any right other than the license granted hereunder, in respect of the Licensed Software and any related documents.
2. The User shall, whenever the User uses the Licensed Software, comply with any laws relating to the copyright and other intellectual property rights.

Article 5 Indemnification of Licensor

1. Neither the Licensor nor the Original Rightholder shall be liable for any damage incurred by the User or any third party due to the exercise of the license granted to the User under this Agreement, unless otherwise restricted by law.
2. The Licensor will offer no guarantee for the merchantability, convertibility and consistency with certain objective of the Licensed Software.

Article 6 Liability to Third Party

If any dispute has arisen with any third party due to an infringement upon a copyright, patent or any other intellectual property right that was caused by the User’s use of the Licensed Software, the User shall settle such dispute at the User’s own cost and hold the Licensor and the Original Rightholder harmless from any inconvenience it may cause.

Article 7 Confidentiality

The User shall keep the confidentiality of such portion of the Licensed Software, related documents thereof or any other information to be granted under this Agreement, as well as the conditions of this Agreement as has not yet entered the public domain, and shall not disclose or divulge the same to any third party without approval of the Licensor.

Article 8 Termination

In case the User falls under any of the events described in the following items, the Licensor may immediately terminate this Agreement or claim that the User compensates for the damage incurred by the Licensor due to such event:

- (1) when the User violated any provision of this Agreement; or
- (2) when a petition has been filed against the User for an attachment, provisional attachment, provisional disposition or any other compulsory execution.

Article 9 Destruction of the Licensed Software

If this Agreement is terminated pursuant to the provision of Article 8, the User shall destroy the Licensed Software, any related documents and copies thereof within two (2) weeks from such date of termination.

Article 10 Export Restriction

1. The User shall understand that the Licensed Software shall be subject to the export restrictions adopted by the country of User and any other countries.
2. The User shall agree that the software will be subject to any and all applicable international and domestic laws including the export control regulation of the country of User and any other countries, and any restrictions concerning the end-users, the use by end-users and importing countries to be provided by the country of User and any other countries, and any other governmental authorities.
3. If the User is an agency of the United States of America (the "Government"), the User acknowledge Licensor's representation that the Licensed Software is a "Commercial Item" as defined in Federal Acquisition Regulation (FAR) part 2.101(g) consisting unpublished "Commercial Computer Software" as those items are used at FAR part 12.212 and is only license the User with the same use right Licensor grants all commercial end users pursuant to the terms of this Agreement.

Article 11 Miscellaneous

1. In the event any part of this Agreement is invalidated by operation of law, the residual provisions shall continue in force.
2. Matters not stipulated in this Agreement or any ambiguity or question raised in the construction of this Agreement shall be provided or settled upon good-faith consultation between the Licensor and the User.
3. The Licensor and the User hereby agree that this Agreement is governed by the laws of Japan, and any dispute arising from, and relating to the rights and obligations under, this Agreement shall be submitted to the exclusive jurisdiction of the Tokyo District Court for its first instance.

Important Notice concerning the Software

Software License Attached to the Product :

The Software embedded in the Product is composed of several independent software components, and in each of such individual components (hereinafter the "Licensed Software"), a copyright of either JVCKENWOOD Corporation (hereinafter "JKC") or a third party subsists.

The Product uses the software component designated in the End-User License Agreement that was executed between JKC and a third party (hereinafter "EULA").

The Licensed Software covers those corresponding to free software, and, as a condition of distribution of the software component in executable format which is based on the license granted under the GNU General Public License or Lesser General Public License (hereinafter "GPL/LGPL"), it requires an availability of the source code for the relevant component. Please refer to the following URL concerning the distribution of the source code;

<https://www3.jvckenwood.com/download/gpl/index.html>

Please note that we are unable to answer any inquiry relating to the contents, etc. of the source code. In addition, the Licensed Software includes the software developed or created independently by JKC and there exists an ownership of JKC in such software and any accompanying documents, which is protected by the Copyright Law, any international treaties and other applicable laws. As to matters concerning the handling by JKC of the software components, please refer to the "Software License Agreement" attached hereto. Please note that any software component licensed under "EULA" which is not subject to "GPL/LGPL", and those developed or created independently by JKC shall not be subject to the requirement for provision of the source code. The software component distributed under "GPL/LGPL" shall be licensed to users without charge, and, therefore, no warranty is given for such software component, either express or implied, within the scope of the applicable laws and regulations. Unless otherwise permitted by applicable laws and regulations or agreed in written form, none of the owners of the copyright or persons entitled to alter or redistribute the software component under the said license shall have any liability for any type of damage or loss resulting from the use of or inability to use such software component. For further details of the conditions of use of such software component or matters required to be complied with, please refer to the relevant "GPL/LGPL".

Users are urged to read the details for the relevant license carefully before using the software component covered by "GPL/LGPL" and embedded in the Product. Since the terms and conditions of individual licenses are provided by parties other than JKC, the original English version will be displayed by the Product or the Settings screen.

- ① Access the camera from the Web browser
- ② Click "Information" on the left side of the screen
- ③ Press the "Open Source License" button in the "Information" menu screen

**4K PTZ REMOTE CAMERA
KY-PZ510NWU/KY-PZ510NWE
KY-PZ510NB/KY-PZ510NBE
KY-PZ510WU/KY-PZ510WE
KY-PZ510BU/KY-PZ510BE**

JVC